



# **Creation of an appropriate reporting structure for Continuous Improvement**

July 4th 2007

Building a reporting structure for  
Sara Lee International

R.P.Met



# Creating a Mindset for Continuous Improvement

Building a reporting structure for  
Sara Lee International

## Paper final assignment

### Company

Sara Lee International  
Vleutensevaart 100  
3532 AD Utrecht  
Tel.: 030-2979111

### Company Companion

Hennie Monsou

### University Companion

Peter Schuur  
Christiaan Katsma

### Author

Roderik Met  
Kanaalstraat 100bis  
3531 CM Utrecht  
Tel.: 06-18633423

## Preface

This paper represents the outcome of my final internship to round up my studies Industrial Engineering and Management at the University of Twente in Enschede. In the summer of 2005 I had a discussion with the study advisor to finalise my studies. We spoke about courses and two internships which had to be done. In February 2006 I started a training on the job at Uniq Salads in Losser. My assignment was to introduce a new warehouse management system. During this assignment I became interested in the UQ Excellence program, resulting in a positive working environment and shorter lead times. The UQ Excellence program was based on Lean Manufacturing.

Lean Manufacturing is applied exemplarily by Toyota and is seen as the new concept for companies. Sara Lee International is applying Lean not only to its operations organisation but even beyond on non operations. Interested in the concepts of Lean and Sara Lee International as a great opportunity to finalise my studies with an internship I applied for a position.

I started in September 2006 with introductions to the organization and the principles of continuous improvement. Immediate in my first week I was involved in a workshop for process improvement. Within Sara Lee International I have been working in the Continuous Improvement PMO team. The purpose of this team was to design and implement a reporting structure for continuous improvement. As follow up I have been in a supportive role for the CI department. The PMO team reported monthly to the board of managers. Daily work was tracking activities, numbers on people trained and improving systems and processes.

After eight months at Sara Lee International I look back on a valuable period. I have been working on the assignment with a lot of enthusiasm. This pleasure was caused by the character of the assignment and the comfortable working environment. I would like to use the opportunity to thank all the people inside and outside Sara Lee International whom I have been working with, and the supervision teachers from university. I would like to specially thank Wim Heine for offering me this position in Sara Lee International and Hennie Monsou for his direct support as head of the continuous improvement PMO team.

Special thanks go out to my family who has always been supporting during my studies.

Roderik Met

Utrecht, July 4<sup>th</sup> 2007

## Management Summary

Sara Lee is an international company manufacturing and selling high quality, branded consumer packaged goods. The organisation is divided in three business segments. Two of these business segments, Sara Lee Food & Beverage and Sara Lee Foodservice focus on the United States operations. Sara Lee International is the last business segment and focuses on the operations in world wide countries, except the US. Sara Lee has adopted the continuous improvement to be able to compete in the market and have an edge over their market competitors. This report presents a reporting structure for Sara Lee International to report on the progress of implementing the continuous improvement methodology in the organisation. Continuous improvement starts by identifying the value stream. The focus of this report is to facilitate in good value stream mapping. Secondary there needs to be a structure for training the employees on different aspects of continuous improvement. Tools need to be trained and explained so that they can be used and applied in daily work. The third and last focus of this report is to introduce performance management in the continuous improvement structure.

To be able to identify the value stream in operations as well as in non-operations a special hierarchy structure was identified. A structure has been developed for the new situation in which the value stream has it's own level. The value stream map is the basis for the ideal state. To emphasise the importance of the value stream it is also a special phase in the reporting structure for Operations and Non-operations.

By designing a common process for all projects in Operations and Non-operations a much higher level of insight is given to participants in a project. These common processes are based on the cyclical way of organizational learning. They are called plan-do-check-act cycles. These cyclical processes start with a plan to create a schedule for an improvement on a machine or process. This plan has to be executed by a team, built up of people involved in the process. They are also involved in setting up the plan. This reveals show the bottom up methodology of continuous improving. A check of the new situation is needed to see if the future state is achieved. If not, adjustments can be made or by starting a new cycle the incremental improvement can proceed.

Many papers and books state that continuous improvement is about creating a mindset among all employees in the organisation. Top management needs to be involved to support and understand ideas from the lowest organisational level. Top management has to support the ideas of continuous improvement. The improvements on process and production lines need to be made by middle management and line operators. This results in the need for a training structure for implementing continuous improvement. This report presents a training structure which is able to train every level of the

organization. At the production line a small awareness event can be organized about implementing a continuous improvement tool. Whereas an extensive CI facilitator program is available to train leading figures for implementing continuous improvement in all parts of the organization. The training structure is also available on the intranet of the company. All training material is accessible to the employees.

The structure on the intranet is roughly divided in two parts. One part is set up for corporate management support by upper management. The other part focuses on local management support by team leaders and team members improving their daily work processes.

<b>PREFACE .....</b>	<b>1</b>
<b>MANAGEMENT SUMMARY .....</b>	<b>2</b>
<b>1. INTRODUCTION .....</b>	<b>6</b>
1.1 SARA LEE CORPORATION .....	6
1.1.1 <i>Business Groups</i> .....	6
1.1.2 <i>Mission Statement</i> .....	8
1.1.3 <i>Vision</i> .....	8
1.1.4 <i>Values</i> .....	8
1.1.5 <i>Transformation</i> .....	9
1.1.6 <i>Continuous Improvement</i> .....	10
1.1.7 <i>Goal of Continuous Improvement</i> .....	11
1.1.8 <i>Timeline of processes</i> .....	11
1.2 RESEARCH METHOD .....	13
1.2.1 <i>Problem definition</i> .....	13
1.2.2 <i>Goal</i> .....	13
1.2.3 <i>Problem owners</i> .....	13
1.2.4 <i>Research questions</i> .....	15
1.2.5 <i>Approach</i> .....	15
1.3 STRUCTURE OF THE REPORT .....	16
<b>2. CURRENT SITUATION .....</b>	<b>18</b>
2.1 ROLL-OUT OF CONTINUOUS IMPROVEMENT .....	18
2.2 REPORTING STRUCTURE.....	22
2.2.1 <i>Charters</i> .....	22
2.2.2 <i>Key performance indicators</i> .....	23
2.2.3 <i>S-curves</i> .....	24
2.2.4 <i>Exceptions</i> .....	25
2.2.5 <i>Library</i> .....	25
2.3 REMARKS .....	25
<b>3. CONTINUOUS IMPROVEMENT .....</b>	<b>28</b>
3.1 PRINCIPLES OF CONTINUOUS IMPROVEMENT .....	28
3.1.1 <i>Value</i> .....	29
3.1.2 <i>Value Stream</i> .....	29
3.1.3 <i>Flow</i> .....	32
3.1.4 <i>Pull</i> .....	36
3.1.5 <i>Perfection</i> .....	36
3.2 ORGANIZATIONAL CHANGE.....	36
3.3 PERFORMANCE MANAGEMENT .....	37
3.4 CONCLUSION.....	38
<b>4. FUTURE STATE .....</b>	<b>40</b>
4.1 INTRANET ENVIRONMENT .....	40
4.2 HIERARCHY STRUCTURE .....	42
4.3 SMARTTOOL FOR REPORTING .....	46
4.3.1 <i>Managerial control</i> .....	47
4.4 COMMON PROCESSES .....	50
4.4.1 <i>Non-operations</i> .....	51

---

4.4.2 Operations.....	55
4.4.3 Reporting requirements.....	58
4.5 TRAINING STRUCTURE.....	59
<b>5. PROPOSED SOLUTION.....</b>	<b>62</b>
<b>6. CONCLUSION AND RECOMMENDATIONS .....</b>	<b>66</b>
<b>REFERENCES .....</b>	<b>69</b>
<b>GLOSSARY .....</b>	<b>70</b>
<b>APPENDIX A .....</b>	<b>71</b>
<b>APPENDIX B .....</b>	<b>72</b>
<b>APPENDIX C .....</b>	<b>74</b>
<b>APPENDIX D .....</b>	<b>76</b>
<b>APPENDIX E .....</b>	<b>77</b>

## 1. Introduction

As introduction to the report I will start with a description of the company where I have been working for in the past months. I will highlight the three business groups of Sara Lee Corporation. Succeeding this general description I will give an impression of the transformation process which Sara Lee started in 2005 to reposition the company and describe the background of continuous improvement for Sara Lee. In the second paragraph the research method will be pointed out. The last paragraph of this chapter describes the structure of the report.

### 1.1 Sara Lee Corporation

From its delicious Douwe Egberts coffee to its Sanex shower gel, Sara Lee is in touch with consumers through innovative products they use virtually every day. Chicago-based Sara Lee Corporation is a global manufacturer and marketer of high quality, branded consumer packaged goods that have become household names around the world. Sara Lee's greatest strength is its skill at developing mega brands—products people everywhere know and trust. Behind these mega brands, Sara Lee has a management team dedicated to positioning Sara Lee for continued growth.

#### 1.1.1 Business Groups

Sara Lee Corporation is setup out of three business segments:

- Sara Lee Food & Beverage
- Sara Lee Foodservice
- Sara Lee International

*Sara Lee Food & Beverage* is the North American retail food division of Sara Lee Corporation. Based in Chicago and lead by C.J. Fraleigh the Food & Beverage group develops and markets baked goods, packaged meats and coffee. Leading brands and products include Sara Lee fresh breads, frozen desserts and deli meats, Hillshire Farm lunchmeats, Jimmy Dean sausage and breakfast foods, Ball Park franks and the Senseo single-serve premium coffee system.

*Sara Lee Foodservice* also operates from Chicago. This business group is lead by J.W. Nolan. Sara Lee Foodservice is a leading supplier of integrated coffee, meats and bakery solutions to a broad base of customers across North America. The business markets products enjoyed away from home under such well-known brand names as Douwe Egberts, Superior Coffee and Paradise beverages; Sara Lee and Chef Pierre bakery products; and Sara Lee, Jimmy Dean, Ball Park and Hillshire Farm meats. In addition, some products are sold under customer brands.



Using a customer-centric marketing approach that leverages comprehensive category expertise and a tradition of selling excellence, Sara Lee Foodservice is positioned for long-term, profitable growth. The business goes to market through foodservice distribution partners as well as through an extensive direct route delivery system, offering innovative Sara Lee products to full- and quick-service restaurants, retail establishments, schools, healthcare facilities, hospitality venues, warehouses and other foodservice operators.

**Sara Lee International** has its headquarters in Utrecht, the Netherlands. This business group comes under the responsibility of A. Nühn. Sara Lee International manages Sara Lee's non-US Coffee and Tea businesses, the worldwide Household and Body Care operations and the non-US Bakery businesses. This is done by five business segments: Coffee and Tea, Household and Body Care, Fresh bread and baked goods, Frozen desserts and baked goods and number five is Refrigerated dough and baked goods.

Sara Lee International markets a wide range of brands across the world, many of which are leader in their market. International brands such as Douwe Egberts coffee, Pickwick tea, Natreen sweeteners, Sanex body care products and Ambi Pur air fresheners are established success-stories in many countries. In fact, the Sara Lee Kiwi brand ranks number one in shoe care worldwide and is sold in nearly 200 countries.

Sara Lee International also has an impressive offering of local brands, many of which are household names in their home countries. In Spain, connoisseurs of good coffee cherish the Marcilla brand. It is a similar picture in France with Maison du Café, Café Pilão in Brazil and in Denmark with Merrild. Meanwhile, in the United Kingdom, Sara Lee's Radox brand of body care products is a deeply embedded household name. In Germany, the same applies to Duschdas.



Figure 1: Sara Lee Brands

The Financial situation of Sara Lee is shown in figure 2. This figure is an abstract of the financial report over fiscal year 06.

Results of Operations	July 1 <sup>st</sup> , 2006	July 2 <sup>nd</sup> , 2005
<b>Continuing operations</b>		
Net Sales	15.944	16.029
Operating Income	911	1.369
Income before income taxes	683	1.180
Income	410	1.081
Eff. Tax Rate	40 %	8.4 %
<b>Income per share of common stock</b>		
Basic	0.54	1.37
Diluted	0.53	1.36
<b>(Loss)income from discontinued operations</b>	256	362
<b>Gain on sale of discontinued operations</b>	401	-
<b>Net income</b>	555	719
<b>Financial Position</b>		
Total assets	14.522	14.300
Total debts	5.959	4.731
<b>Other Information</b>		
Net cashflow from operating activities	1.232	1.350
Number of employees	109.000	143.000

Figure 2: Facts & Figures(financial report FY 06)

### 1.1.2 Mission Statement

The mission of Sara Lee is *To Simply delight you... every day.* As a part of this mission Sara Lee has to gather around its customer and carefully listen what the customer requires.

### 1.1.3 Vision

Sara Lee's vision is *To be the first choice of consumers and customers around the world by bringing together innovative ideas, continuous improvement and people who make things happen.*

### 1.1.4 Values

Sara Lee has identified five corporate values

- Act with *integrity*
- Use *imagination*
- Be *inclusive*
- Work as a *team*
- Have *passion* to excel

The first value of Sara Lee is to act with integrity, model and inspire high levels of integrity and trust. Use imagination, challenge the way things have

been done in the past, by seeking exposure to new ideas and new ways of looking at things. Be inclusive, proactively develop a culture where people with diverse perspectives, styles and experiences feel valued, included and enabled to contribute to business success. Work as a team, build teams that achieve great things together. Fifth value is to have passion to excel, enthusiastically drive for the success of Sara Lee.

### 1.1.5 Transformation

In February 2005 Sara Lee Corporation announced a comprehensive transformation plan designed to dramatically improve performance and better position Sara Lee for long-term growth. This plan will transform the entire enterprise into a tightly focused food, beverage and household products company and enable Sara Lee to compete more successfully in today's dynamic marketplace and thereby generate consistent, long-term top line growth and bottom-line profitability for its shareholders.

The new organization structure consists of three business segments.

1. Sara Lee Food & Beverage includes the bakery, packaged meats and Senseo coffee businesses in North America.
2. Sara Lee Foodservice is comprised of the North American foodservice business in the bakery, coffee and meats foodservice segments.
3. The third business segment is Sara Lee International, which includes the bakery and beverage businesses outside of North America and the global household products business. For the business segments in North America, all employees will be located in a new headquarters in Downers Grove, Illinois. Sara Lee International will continue to have its main offices in Utrecht, The Netherlands.

The transformation plan also included the spin-off of one business and several divestitures. The Branded Apparel business in the Americas and Asia will be spun off into an independent, publicly traded company. Divestitures in the European apparel business included the European package meats business, the direct selling business, and the U.S. Retail Coffee business, excluding the Senseo brand. These divestitures and the Branded Apparel spin-off represent approximately 40 percent of the company's annual revenues.

Sara Lee intends to use the proceeds generated from these dispositions and savings from several cost reduction initiatives to fund investment in its growth businesses and strengthen its balance sheet. Key cost reduction initiatives currently underway include centralizing purchasing, supporting administrative needs through shared services and establishing a common technology platform.

### 1.1.6 Continuous Improvement

Sara Lee has embraced LEAN or Continuous Improvement to focus on its on processes. Eliminate waste, taking non value added tasks out of everything Sara Lee employees do and eliminating things the customer will not pay for.

Continuous Improvement is going to be applied in three areas:

1. Priority Processes
2. IT Projects / Programs
3. Daily work

Priority Processes are processes that will provide Sara Lee with a competitive advantage over its market competitors and improve the operational excellence. These processes are collectively felt to make the biggest difference in business to help Sara Lee achieve its goals. Currently, these priority processes are Innovation, Supply & Operations, Pricing / Trade Spend, Business Planning and Customer Management Excellence.

IT projects are initiatives focused on delivering a common infrastructure and information technology capabilities needed to accelerate Sara Lee's move toward operational excellence. Companies fail by putting IT systems in place before optimizing and creating common processes. For example order to cash and procure to pay.

Daily work are the day-to-day tasks and processes required for running the business. Every individual and team in Sara Lee must continuously look for better ways to do every aspect of their work. To achieve this, workshops are held to draw current state on a brown paper. This current state is discussed and an ideal state is created. The name ideal state is then replaced by future state. This future state does not have to be reached within weeks. It may take weeks or a few months, up to 18 months to be achieved. The idea is to improve every day by taking small steps instead of one big step at once. The explanation of the Continuous Improvement process is also shown in Figure 3.

## Continuous Improvement: What is it?

Sara Lee is cultivating a continuous improvement mindset by applying a LEAN approach to priority processes, information technology projects and programs, and daily work, all supported by tools and executed by people.

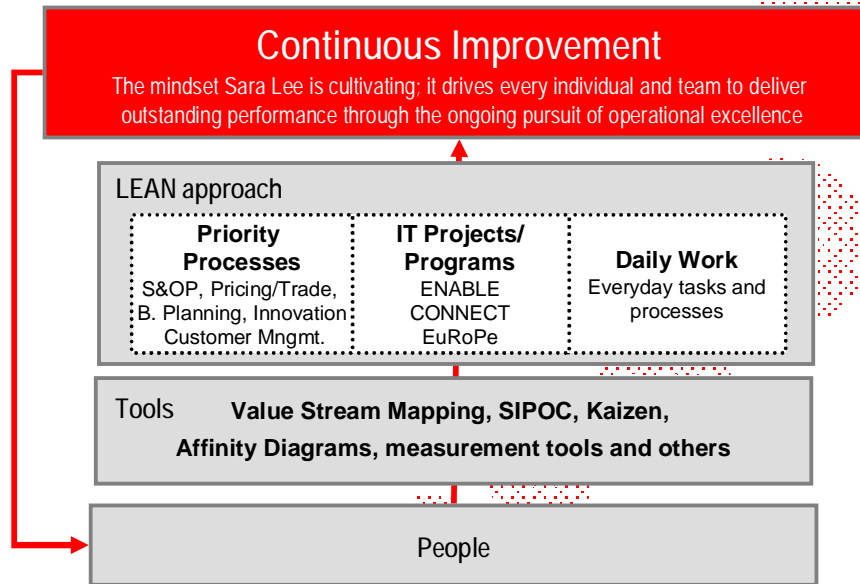

**ONWARD.UPWARD.**  
The Power of the New Sara Lee

Figure 3: Continuous Improvement framework (source: presentation CEO)

### 1.1.7 Goal of Continuous Improvement

The goal of the continuous improvement (CI) approach is a short term and long term one. On the short term the goal is to increase all Sara Lee associates' knowledge of Lean, and develop the skills to use the principles and tools within their roles.

The long term goal of continuous improvement is to develop a culture, a tradition of excellence, founded in lean principles and tools that will drive operational performance within Sara Lee over the next decade and beyond.

### 1.1.8 Timeline of processes

To put the transformation process and the continuous improvement initiatives together in one framework I have created a timeline in figure 4 below. This figure shows the start of the transformation process in 2005. During transformation the number of brands was reduced to create a smaller portfolio of leading brands. Brands like Duyvis and Lassie were sold to other market parties. Beside this reduction in the brands portfolio also several divisions, like Meat Europe and Direct Selling were sold. They were not fitting properly in the future direction of the company. Concurrently with the business process transformation program continuous improvement initiatives

were started in Food & Beverage and Foodservice, the two US business segments. This was followed by implementation of Lean manufacturing in all US factories in 2006 and the first factory within SLI, the Senseo coffee plant Grimbergen. This program developed towards other SLI factories. It was determined to start implementing continuous improvement also in Non-Operations in June 2006. A twelve week training program for continuous improvement group leaders started. They were appointed to lead the change in the company. In November 2006 a reporting structure to report on continuous improvement implementation in Sara Lee International was built. This design of this process will be described in this report.

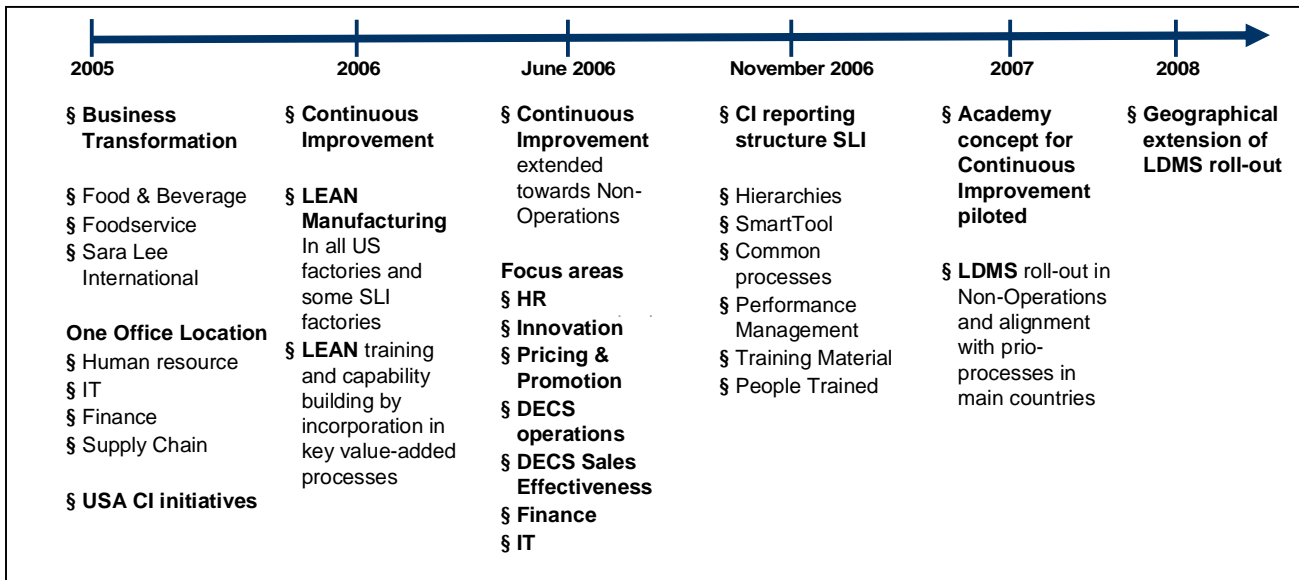

Figure 4: Timeline

In 2007 the concept of a continuous improvement academy is piloted for training materials. Special training kits containing theoretical papers, materials, simulations and games are made available. The materials already available in English are translated to other main languages. In the Non-Operations environment LDMS, Lean Daily Management Systems will be installed to gradually build the foundation skills necessary for success of continuous improvement. This will first be done in the main countries. In 2008 and the years beyond roll-out this will spread to all other countries.

## 1.2 Research Method

In the Dutch language we have an expression stating that *“a good start is half the work”*! Related to the report of my final internship this phrase can be translated in a good research method is a big step towards useful result. In this second paragraph I will outline a solid research method which can serve a guideline for the rest of the report.

### 1.2.1 Problem definition

The cultural change for adopting continuous improvement must start at the top and cascade throughout the organization. It is not a simple bottom up program but has many links with strategic goals set by top management (Kerrin, 1999). An extensive program of training is used to expand the Lean methodology in the company. To supervise this change management a special continuous improvement department has been established. Senior leadership wants to track the progress of the lean development throughout the organisation. The CI department is assisted by a project management organization to help reporting on progress and results. The project team has to track the number of people trained, update schedules of Continuous Improvement Workshops scheduled. Important is also to report key performance indicators and financial data on how much is saved by using Lean.

It is a difficult question how to setup a relevant infrastructure for reporting progress to the continuous improvement department, the Sara Lee International board of managers and the Sara Lee Corporation board of managers. Which information is relevant on different levels.

Continuous Improvement Change Agents and -Group Leaders are using a special SmartTool to report on the financial side of their projects. They have a target for Fiscal Year 07 and Fiscal Year 08. The SmartTool also registers the actual amount achieved and displays the gap between target and Actual. If there is a gap the SmartTool will indicate if there are enough activities approved to close this gap. In the SmartTool the Continuous Improvement Change Agents and -Group Leaders have the possibility to track KPI's. For instance these KPI's can be number of FTE, Overall Equipment Efficiency, average visits per route, sales per visit, number of stocks or the number of calls solved by the helpdesk. These KPI's can vary from project to project.

### 1.2.2 Goal

The goal of this research is to create a reporting structure that is appropriate to support Continuous Improvement within Sara Lee International.

### 1.2.3 Problem owners

Sara Lee's top management has taken the decision to start transforming into a LEAN organisation. The senior leadership team identified Continuous

Improvement as a key element to a future of success of the company and stands firmly behind it. The continuous improvement program is not in addition to all the work that's going on right now but is in support of the commitments employees have made in their operating plans. The question arises how to implement the program in the existing new structure after the transformation plan.

Within Sara Lee International a special Continuous Improvement department has been established to implement LEAN. The organizational chart of the functions and persons is shown in figure 5. The continuous improvement department consists of three persons who perform a leading role. The directors continuous improvement Operations and Non-operations are responsible for the implementation of the continuous improvement methodology in the organization. The Director Continuous Improvement Non-operations reports directly to the board of management. He also has responsibility for all annual operating plan Initiatives in Non Operations. The Director Continuous Improvement Operations has responsibility for all annual operating plan Initiatives in Operations. Operations is responsible for two branches: Manufacturing and Supply Chain. As Director he reports to the Vice President Manufacturing SLI. This function is directly linked under the Senior VP Operations which reports direct to the board of management. Third member of the continuous improvement team is the Director continuous improvement Organizational Development. He is the expert on Human Resource. He reports to the Vice President Human Resources SLI which directly falls under supervision of the SLI board.

The team has a mixed background of Non-Operations, Manufacturing and Human Resource. They have been chosen to best implement the Continuous Improvement program in the organization.

Besides these three leading functions in the Continuous Improvement department there is a support team. This CI project management organization team is lead by Vice President Finance Shared Services. The purpose of this team is to facilitate the Continuous Improvement department in reporting to their superiors. The leader of the CI PMO team has been active within the transformation process and was asked to support the Continuous Improvement department because of his excellent results in project management.



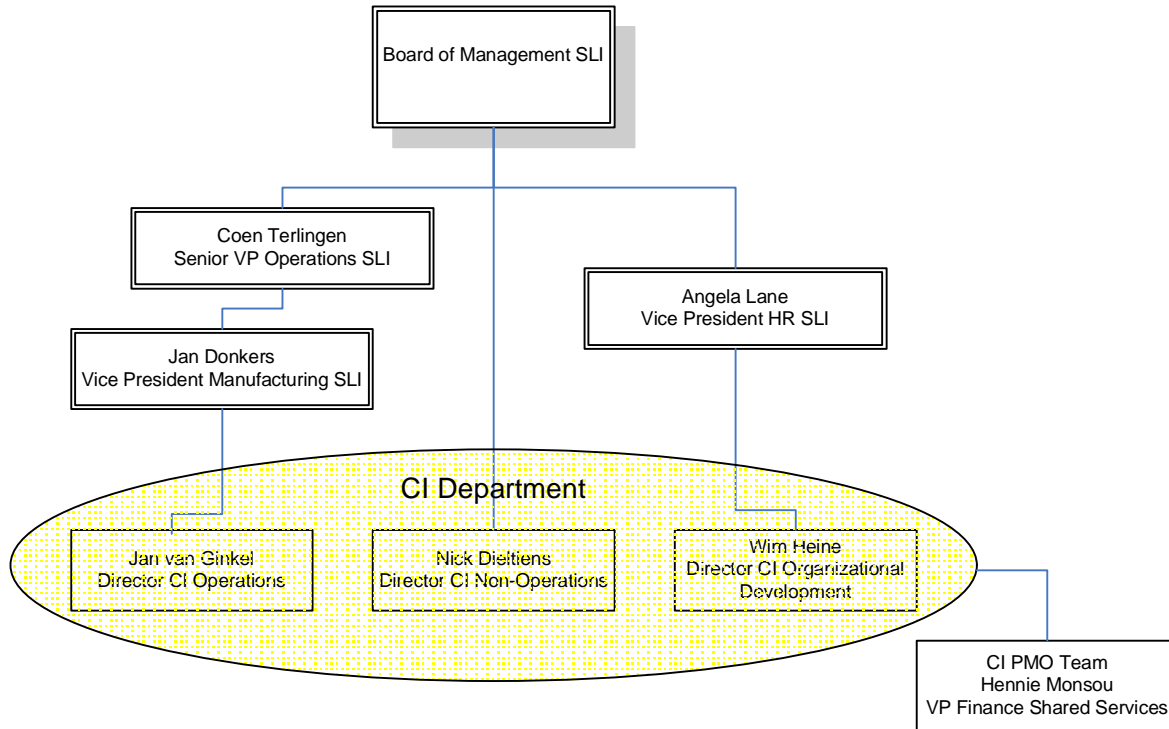

Figure 5: Organizational chart

### 1.2.4 Research questions

#### Current Situation(IST)

- 1) What is LEAN or Continuous Improvement?
- 2) How is LEAN applied within Sara Lee International?
- 3) Which information is reported to steer Lean Implementation?

#### Future Situation(SOLL)

- 1) How can we build a reporting structure to provide required information?
- 2) Which specific modules need to be in place for reporting?
- 3) Can a common reporting structure be built?

### 1.2.5 Approach

The approach to the problem was rather straightforward. I started to work with the PMO team in September. My role in the PMO team was to analyse the current state and share my findings with my colleagues. Besides this analysis I also had an important role in idea generation about the new situation. The PMO team itself was established late September. The assignment from the CI department was to provide them with a reporting structure by the end of October. To be able to deliver at this pace a lot of brainstorming sessions were organized. By telephone conferencing a lot of information was gathered from employees in the field of continuous

improvement. This useful information was combined with findings from Sara Lee Corporate where continuous improvement initiatives were already running for some time. The methods used are shown in table 1.

Because of the immediate need for a reporting system it had to be created rather quickly. A research for months was not possible. A good fundament needed to be formed by a current state analyses. This current state analysis enabled the PMO team in creating a new working situation at once. I have also been in a supportive role for the CI department. The PMO team reported monthly to the board of managers. Daily work was tracking activities, numbers on people trained and improving systems and processes.

Method	Description
Conference Call	Weekly basis - attended by continuous improvement group leaders and members of CI department
Brainstorm session	Sessions with five members of the CI PMO team inside a room with a drawing board.
Documentation	Information available within Sara Lee Corporate on the intranet, reports on continuous improvement workshops and company newsletters
Participant observation	Continuous improvement workshops on site in Utrecht

Table 1: methods used in this study

### 1.3 Structure of the report

In this first chapter I have presented the context of the assignment at Sara Lee International. The most important goal is to create a reporting structure which is up and running within several weeks. The initiatives have already started and the big issue is how to report progress to the board of management.

In the remainder of this report I will first describe the current situation of the continuous improvement initiatives. This current state analysis results in a draft for the future state. The third chapter concerns the theory background of continuous improvement and implementation methods. Based on a junction of the previous two chapters chapter four will provide the future state for reporting of continuous improvement. I will not only present a reporting structure; concurrently I present a reporting procedure for operations and non-operations. These procedures are linked to the reporting

structure to create a comprehensive solution for Sara Lee International and even beyond.

Appendices, referred to in this report several times have been added at the back of this report. Table 2 below functions as a bookmark for this report.

Chapter	Description
Chapter 1	Introduction to Sara Lee International and a description of the assignment at Sara Lee International.
Chapter 2	The current situation, consisting of the current roll out as well as the currently on hand reporting structure.
Chapter 3	Theoretical background of continuous improvement, organizational change and performance management. This chapter ends with a framework for the remainder of the report.
Chapter 4	Proposal for future state based on a new hierarchy structure, the SmartTool and creation of common processes.
Chapter 5	Solution based on the proposed solution, the elements mentioned in chapter four.
Chapter 6	Conclusion of this report.

Table 2: Bookmark of this report

## 2. Current situation

Chapter two of this report is used to describe the current situation as observed at the start of the project. In the first paragraph a description of the roll is given. I will describe the existing structure used for reporting progress on continuous improvement in the two US business segments. The analysis of the current state results in a draft picture for the new reporting structure.

### 2.1 Roll-out of continuous improvement

Sara Lee has started to work with continuous improvement in the US business segments. Sara Lee Food & Beverage and Sara Lee Foodservice were the first segments to embrace continuous improvement thinking. They were assisted by an external agency to set-up training material and provide knowledge about Lean. To implement continuous improvement several initiatives were launched. The initiatives have their focus mainly on operations. Within Sara Lee International the focus is also on non operations. This is even in the eyes of gurus a relatively new playground for continuous improvement.

The implementation process of continuous improvement and adopting the theory to create a mindset within the organization is set to a limit of time. This program is not running endlessly, however the continuous improvement methodology will become the ideological fundament for Sara Lee. It is an ongoing cyclical learning process which will be running for years. The thought behind the limited timeframe for support and reporting on implementation is that you cannot forever report on how the implementation is going. At a specific moment in time the organization will reach a point in which it can be stated that Sara Lee International is continuously improving.

In the operations section of continuous improvement all factories are grouped in 6 waves. The starting point was September 2005 and finish date is June 30<sup>th</sup> 2008. The roll-out plan for the Sara Lee International plants is shown in figure 6. A wave method of implementation in factories was chosen especially not to disrupt all factories and processes at the same time. By doing the implementation in waves only a small set of factories would start an implementation path at a time. Dividing the factories in waves provides more control to the CI department. As can be concluded from the wave pattern in figure 6 all factories will be applying continuous improvement at the end of fiscal year 08. Four times during this roll-out a lean manufacturing college will be organized. During such a meeting of two up to five days the CI facilitators will meet together with leading management. The running initiatives, results and waves will be discussed. There is also time to share best practices and invite experts like D. Jones for lectures.

## High Level Roll-out Plan SLI Plants

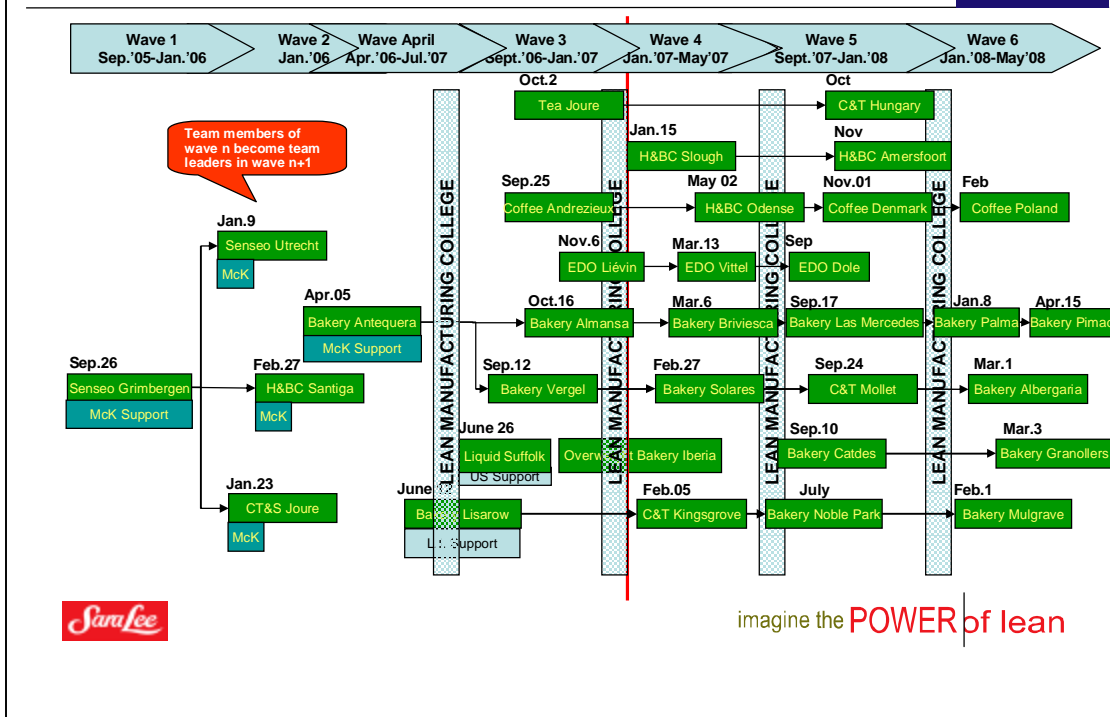

Figure 6: Roll-out plan plants (source: CI strategy report)

Roll-out started in September 2005 in Senseo coffee plant Grimbergen. This factory was used as a kind of playground to test certain practices and reactions of employees. The implementation was done by Sara Lee employees supported by experts from McKinsey. Currently the Grimbergen factory has all people trained. They use several CI techniques like 5s and kaizens to improve their performance day by day.

Figure 7 is in short a picture of the approach used in the Grimbergen coffee plant. Target setting is done by value stream analysis. This can result in higher overall equipment efficiency or the reduction of scrap and rework. The tactical implementation plan represents the implementation plan for the lean program. A sample of this kind of planning, at a high machine level is shown in appendix A. There are three value streams identified, Senseo, Anvar / Whole bean and DeVac. Within each value stream the machines or production lines are represented by arrows. For instance in the value stream Senseo, a production line is Opem 22, or Cloud 53. A more detailed plan per line is created in a tactical implementation plan on a one step lower level. This more detailed planning shows the objective and the impact on OEE, FTE or scrap. The planning describes the duration and what kind of continuous improvement tool is needed. A detailed version of this planning is also shown in appendix A, the second picture.

The approach in figure 7 also shows how idea management is done. Memo's can be used by employees to post their ideas. Kaizen events result in improvements and new ideas. These ideas can be classified and can be used for performance tracking. I will further discuss this when I describe the SmartTool in paragraph 4.3.

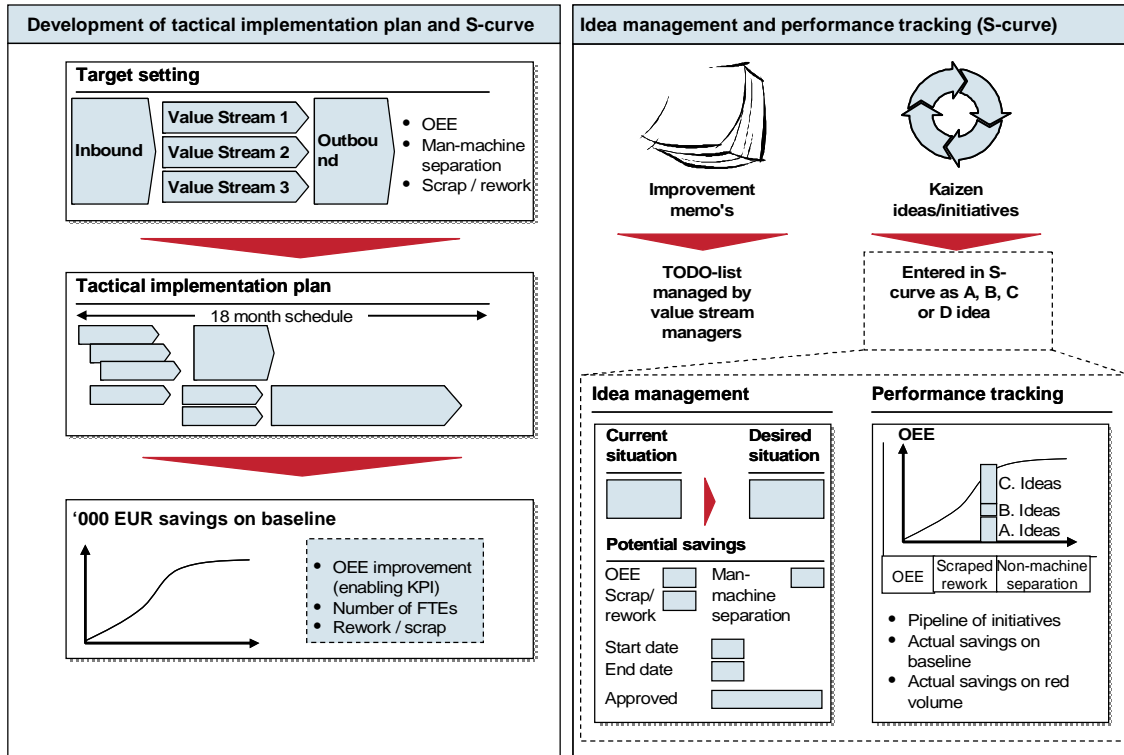

Figure 7: Approach (source: Grimbergen report out)

As a result of this approach Senseo coffee plant Grimbergen managed to reduce the percentage of scrap and rework from 5,8 percent to 2,9 percent. This is a reduction of 50 percent. Strive is to become a zero defect plant, with no scrap and rework. Another result was a reduction in the number of FTE by 65. At an average yearly personnel cost of € 42.227 (based on figures of FY06) this results is a yearly savings equal to 2,74 million Euros.

The finish date for continuous improvement is June 30<sup>th</sup> 2008. This is also the deadline for supply chain and non-operations. They will have to be Lean, or continuously improving by the end of fiscal year 08 as well. These two business segments started at the beginning of fiscal year 07. Sara Lee employees in supply chain and non-operations were trained by continuous improvement experts from Kaufman group. The roll out plan for Sara Lee International supply chain is shown in figure 8. This figure shows four focus areas

- Lean SC
- CI Value Stream

- Customer Collaboration
- S&OP (supply & operations).

In Lean SC the focus is mainly on the review of stock keeping units (SKU's). Reduce the number of SKU's and improve the cashflow of the remaining set of products. This is done per country, per brand or per product range in a brand. It is also combined with lean manufacturing. KG support stands for support from Kaufman Global, a training and consultancy company. LEI support means support from the Lean Institute. CI Value Stream focuses on the supply of coffee beans from the warehouses to the factories. In Customer collaboration the aim is to have a perfect order system, orders that are touch less, complete, on time, invoiced correctly and damage free.

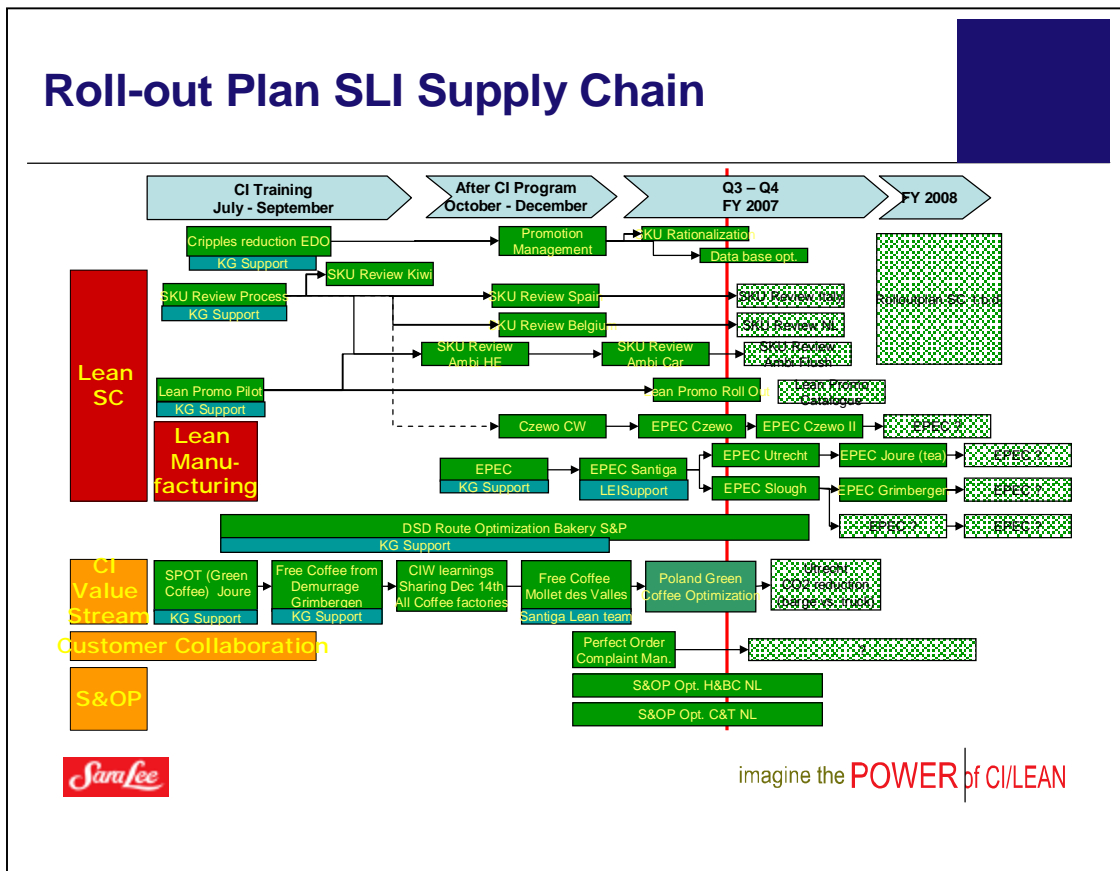

Figure 8: Roll-out plan SC (source: CI strategy report)

To set up a continuous improvement culture a cultural change must start. Employees will need to analyse their own working procedures day by day and improve by making small steps every day. Creating a mindset for continuous improvement is not done overnight. This process takes weeks, months or even years to change the habit of an organization. Sara Lee has assigned corporate talents to become a driver of the new Sara Lee. They are named

Continuous Improvement Change Agents (CICA) and Continuous Improvement Group Leader (CIGL). In this report I will refer to them as CI Facilitators. I have proposed this name to the CI department to overcome confusion. Their tasks and duties are almost the same however a CICA has already realised a bigger amount of projects. The CI Facilitators receive an intensive training program of 16 weeks to learn the theory behind continuous improvement and to practice tools to make Sara Lee continuously improving.

## 2.2 Reporting Structure

For reporting progress on continuous improvement Sara Lee Corporate currently uses the intranet. This intranet environment is called InSite. It is an environment which can be accessed from every office within Sara Lee. On InSite a special page is designed for continuous improvement. SL CI InSite is a page where all initiatives can be tracked.

The current page contains several tabs:

- charters
- key performance indicators
- S-curves
- exceptions
- library function

These aspects will be explained in the next part of this paragraph. The Sara Lee continuous improvement InSite environment is used for Food & Beverage and Foodservice continuous improvement Initiatives. This domain contains all northern American businesses.

### 2.2.1 Charters

The charters provide information about the intention of the initiative. This information is available for everyone in the organisation. The usage of this information is mainly managerial. It contains the name of the initiative and it is stated if it is a priority process yes or no. Priority processes as mentioned in paragraph 1.1.6 will provide the company with a competitive advantage over its competitors. All initiatives are lead by one ore more CICA's or CIGL's. The CICA's are mainly active in operations, CIGL have a focus more on non operations and supply chain. The charters also contain information on the objective, the scope and the key interdependencies of the initiatives. This information is all relatively static. It is provided at the beginning of a project and not a lot of this information is changed afterwards.

There are however some parts of the charter that do change every month.

The CI Facilitator is obliged to update

- the status
- project phase
- stoplight
- percentage complete



The status of the initiative can either be active, completed, deferred or cancelled. With the monthly status update of the CI Facilitator also has a project phase which needs to be specified. The project can be in one out of five phases:

1. (aop) initiative planning
2. planning (pre-work and scoping)
3. execution
4. implementation
5. sustainment

The third field to update is the stoplight. The stoplight colour is either green, orange or red. The colours, as obvious as they can be are explained in figure 9, shown below. The last field is the percentage complete field which is to be filled in a range from 0 % up to 100 %.

These four fields are also marked as sort fields on the SL CI InSite page, as this also applies for CI Facilitator and title. For managerial control this makes it a page easy to overview and to track & control progress and status of initiatives.

	Progress	Interdependency	Resources	Benefits	Costs
	No delays that will impact this or any other project or initiative. Project will be finalised within 60 days from start	Management of integration and interdependence is progressing as planned. No major issues exist.	Resources: - Are fully available - Have the required skills - Are aligned with required effort	On target to deliver 100% of planned benefits	Costs will meet or beat initial target budget
	Delays up to 2 weeks that impact this or another initiative	Management of integration and interdependence is slightly behind expected progress. Some issues exist, however they are minor and are expected to be resolved easily.	Resources: - Only partially available - Do not have all required skills - Not fully aligned with effort (more resources are needed)	On target to deliver at least 80% of benefits	Costs will likely be 1% - 20% over initial target budget
	Delays greater than two weeks that impact this or another initiative.	Management of integration and interdependence is behind expected progress to the point of concern. Issues exist and resolutions will be difficult to achieve. Interdependencies are not defined.	Resources: - Not available - Do not have key skills - Not aligned with the effort- substantially more resources are needed	< than 80% of the benefits are likely	Costs will likely be > 20% over initial target budget

Figure 9: Stoplight Criteria (source: SLC InSite)

### 2.2.2 Key performance indicators

The tab Key performance indicators (KPI's) does provide the KPI's selected per initiative. This is only static information which will not change. Sara Lee has a lot of different KPI's. Per functional area there is a document on the intranet available providing the KPI's to track. Within a continuous improvement initiative the CI Facilitator is not obliged to track all KPI applicable for his functional area. As an example the list of KPI's for supply chain is shown in appendix B. The document not only contains the list of key performance indicators, it also describes it. A definition of the KPI is given, a

numerator and a denominator. This definition is supported by a description of how the KPI should be calculated. In appendix B the calculation of inventory turnover (ITO) is shown as an example of how the document is setup. The CI Facilitator may use this KPI list as a pick list, instead of creating own key performance indicators. Having a centralised set of KPI's is preventing the creation of all different kind of KPI's on local levels. The KPI's are defined by the corporate control and reviewed every year. This financial department has two responsibilities. One is to control the calculations behind a KPI, improve KPI's if necessary. When correct they will enter them into the system. There second task is to prevent proliferation of KPI's.

### 2.2.3 S-curves

The SL CI InSite page also displays S-curves. The S-curves refer to visual displays of savings. An S-curve is a project management tool and consists of a display of cumulative savings plotted against time. An example of an S-curve is shown in figure 10. The X-axis represents the time line, which is divided in periods. Each fiscal year has 12 periods. The Fiscal year of Sara Lee starts at July 1<sup>st</sup> and ends on June 30<sup>th</sup>. The Y-axis represents the Euro savings.

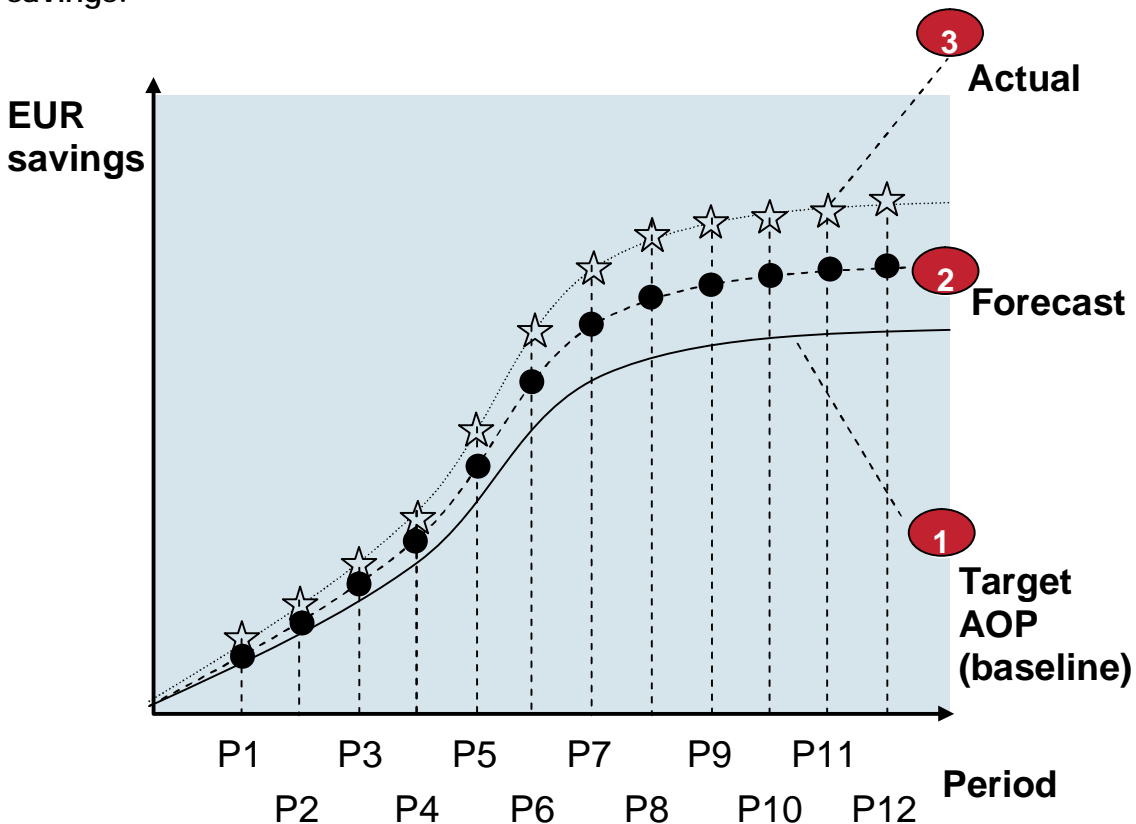

Figure 10: S-curve example

In a normal S-curve, as shown in figure 10, three lines are visible. The first line is the representation of the AOP, the Annual Operating Plan. This operating plan is constructed ultimately in the third quarter of the previous

fiscal year. The AOP line is a fixed line in the s-curve. It is not adjusted over the year. The second line is the forecast of the project. It represents the forecast made by the CI Facilitator at the beginning of the project. The third and last line drawn in the S-curve is the actual level. This actual number is updated per month.

By using this kind of visual control the CI Facilitator can see if the initiative is above or below the forecasted savings. The S-Curves are generated from figures reported via the SmartTool. The SmartTool is an MS Excel based file for reporting financial figures and project management by CI Facilitator. The name of the tool stands for Specific, describe a single observable performance outcome; Measurable, ideally you can measure the result; Achievable, choose a goal that is within reach; Relevant, do not waste energy and Time bound, define completion dates.

#### **2.2.4 Exceptions**

The Exceptions tab on the SL CI InSite page is designed for management by exceptions. Managers or CI Facilitators could create selections of certain initiatives. For instance they could get a display of all initiatives with a red stoplight. Or a view could be created of projects that have reached the sustainment phase.

#### **2.2.5 Library**

The last tab on the SL CI InSite page is the Library. This tab contains documents of several kinds. It contains training material for the CI Facilitators. The planning over workshops is on this part of the site. Every month a continuous improvement newsletter is published and this is also located in the library.

### **2.3 Remarks**

The current SLC CI InSite page shown in figure 11 is used by the US business segments Sara Lee Food & Beverage and Sara Lee Foodservice. .

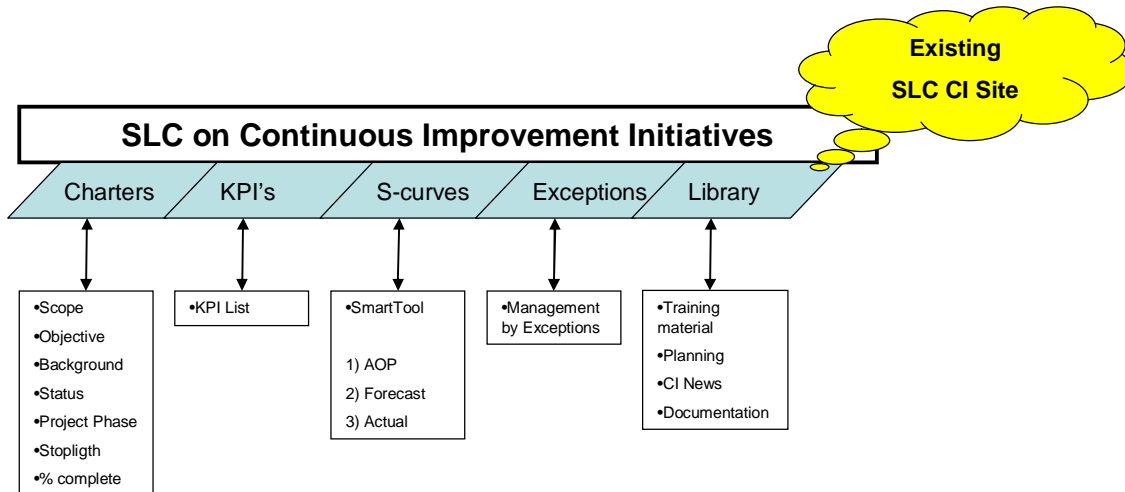

Figure 11: Current situation

For a couple of reasons Sara Lee International can not use this intranet environment for continuous improvement. First, Sara Lee International is a totally different kind of organization. It is operating in multiple countries and as a result of that has a different organizational structure. Secondly the continuous improvement initiative started in the US. Sara Lee International followed just a few years later after the first positive results. Continuous Improvement thinking is much more wide spread in the US than it is in Europe. It is harder to find specialists on continuous improvement in Europe than it is in the US.

Figure 12 shows the draft picture for a new InSite environment. This draft is a result of numerous discussions in with the CI facilitators in conference calls. I combined their ideas with ideas from brainstorming sessions in the CI PMO team.

The Sara Lee Corporate CI Site should be functioning as upper layer of all continuous improvement initiatives. The running initiatives in the Sara Lee Foodservice and Sara Lee Food & Beverage are directly linked to this intranet environment. I wondered if the Sara Lee International initiatives should also be linked directly to this page?

Observing the variety of countries and the different organizational structure I came to the conclusion that it would not be a proper idea to create a direct link for a couple of reasons.

First reason is that Sara Lee International is a different organization with its own board of management. The BoM is a management layer which does not exist in the US Food & Beverage and Foodservice segment.

A second reason is based on the loss of operational control for the CI department over all initiatives. Initiatives within SLI are just starting up and projects in the SLC segments are already running since 2005. I refer also to the timeline in figure 4. A third driver for the decisions not to create a direct link is the size and importance of some information. The information and

output from a local initiative in a small business area does not need to be populated to the highest level in Sara Lee Corporate.

Therefore it was concluded continuous improvement enrolment in Sara Lee International needed a new, own environment on the intranet. This could be a copy of the SLC CI page and linked to the upper layer. The existing SLC CI page would be functioning as the top layer. The challenge is to create a link between the two parts to consolidate the figures from SLI level to the SLC level.

To continue reporting throughout the development process the InSite business team proposed a solution. This solution was based on temporarily reporting figures on a single sheet of paper. These figures would then periodically be gathered by a management assistant. This person (one or more FTE) would then manually input the figures to SLC CI S-curves. This is a rather time consuming activity but could very well function as a first dressing. Although not a bad idea it would mean that a special sheet had to be designed and procedures needed to be defined to implement this in the organization. I proposed instead of continuing to reporting on CI to stop during the design and setup phase of the new SLI environment. The PMO team could then fully concentrate on its assignment.

In the new situation the SmartTools used on local plant and project level could be linked to the new SLI CI page. As a result the data is gathered on Sara Lee International level and the overall totals can than be populated to the overall SLC CI page functioning as upper layer.

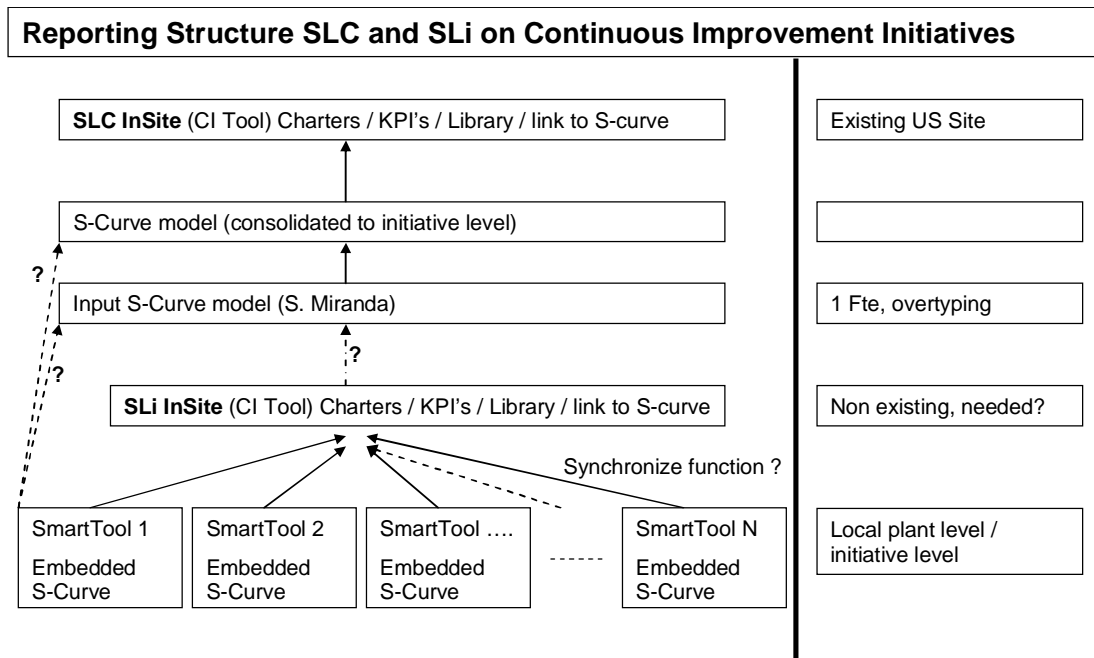

Figure 12: Draft future situation

## 3. Continuous Improvement

A good understanding of the challenge comes with a good explanation on theory. In this chapter I will explain what the meaning of continuous improvement is. I will highlight the five key elements. In the second part I will highlight the process of organizational change required for implementing continuous improvement. During organizational changes management wants to keep up service levels. To do so performance management is needed. The third paragraph discusses performance management within continuous improvement.

### 3.1 Principles of Continuous Improvement

Continuous Improvement is about getting the right things, to the right place, at the right time, in the right quantity while minimizing waste and being flexible and open to change. Lean thinking is what it is also called, it provides a way to do more and more with less and less. Less human effort, less equipment, less time and less space while coming closer to providing customers exactly what they want (Womack, 2003).

Continuous improvement was pioneered in manufacturing companies in Japan and is the antidote towards muda which means waste. The methodology is often named as the cornerstone of the Japanese economy; however continuous improvement is not necessarily seen as a Japanese invention (Kerrin, 1999). The Japanese have become very successful, especially Toyota, with continuous improvement after World War II. A perfect example for them was American based Ford Motor Company. By using the potential of continuous flow the amount of effort required to build a Model T Ford dropped by 90 percent (Womack, 2003). Flow is only one of the principles of continuous improvement. Toyota concluded that continuous flow was essential combined with small-lot production systems. Preventing millions of Model Ts each of them exactly the same like Ford Motor Company had done in the early twenties.

Toyota executive Taiichi Ohno was one of the founders of continuous improvement. He identified the following seven types of muda which absorb resources but do not create value:

1. mistakes which require rectification (defects)
2. production of items customers do not want (overproduction)
3. inventories and remaindered goods pile up (inventories)
4. processing steps which are not actually needed (processing)
5. movement of goods and persons from A to B without a purpose (movement)
6. as a result of number 5 transport

7. groups of people in a downstream position waiting because an upstream activity is not on time schedule (waiting)

Womack and Jones added a final one: goods and services which do not meet the needs of the customer (Womack, 2003).

Continuous Improvement is a philosophy build around five key principles:

- Value*
- Value Stream*
- Flow*
- Pull*
- Perfection*

These key principles will be discussed in the next paragraphs.

### 3.1.1 Value

The starting point for continuous improvement is value. A company that wants to banish waste from its processes needs to identify value. What is value, from the customer's point of view value is why producers exist. As a company you need to specify what creates value from the customer's perspective. Continuous improvement must start with a conscious attempt to precisely define value in terms of specific products with specific capabilities offered at specific prices through a dialogue with specific customers. Rethink your product or service and ignore existing technologies and assumptions (Jones, 2006).

### 3.1.2 Value Stream

The term value stream represents all activities or specific actions (both value added and non-value added) currently needed to bring a specific product through the main flows essential to every product: first activity is the production flow from raw material into the arms of the customer. The second one is the design flow from concept to launch (Rother, 2003).

To think through the value stream it is important to identify all steps across the whole value stream. Within operations, for instance the Senseo coffee plant in Grimbergen, there is a visible movement of material through the factory. This is the physical stream. Starting as a green coffee bean, the bean gets blended and roasted; afterwards it is grinded and packed to end up like Douwe Egberts Senseo pads. Described in just a few steps this is the production process. The value stream map of this process is shown in figure 13.

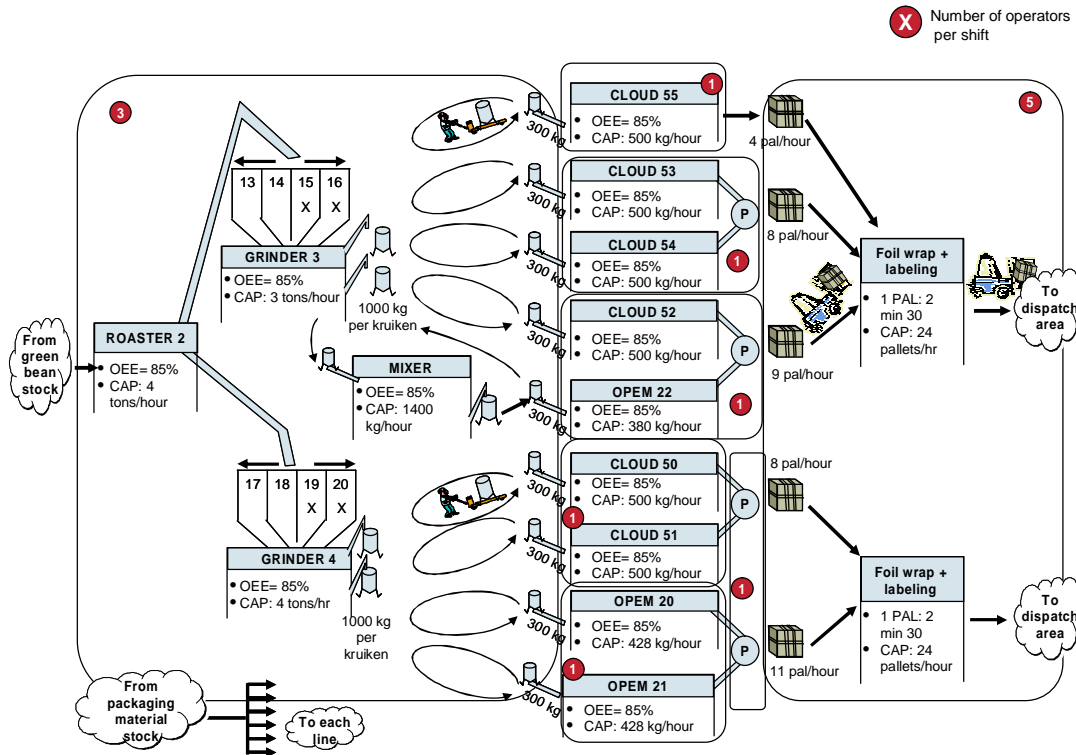

Figure 13: Senseo Value Stream (source: Grimbergen status report)

However, like a coin which has two sides there is also another stream. This other stream is called the information value stream. The information stream tells each process what to do or make and what is up next. In mapping the value stream both streams must be mapped. Figure 13 above shows the material flow through the Senseo value stream. In the figure below I show an example of the counter wise information value stream.

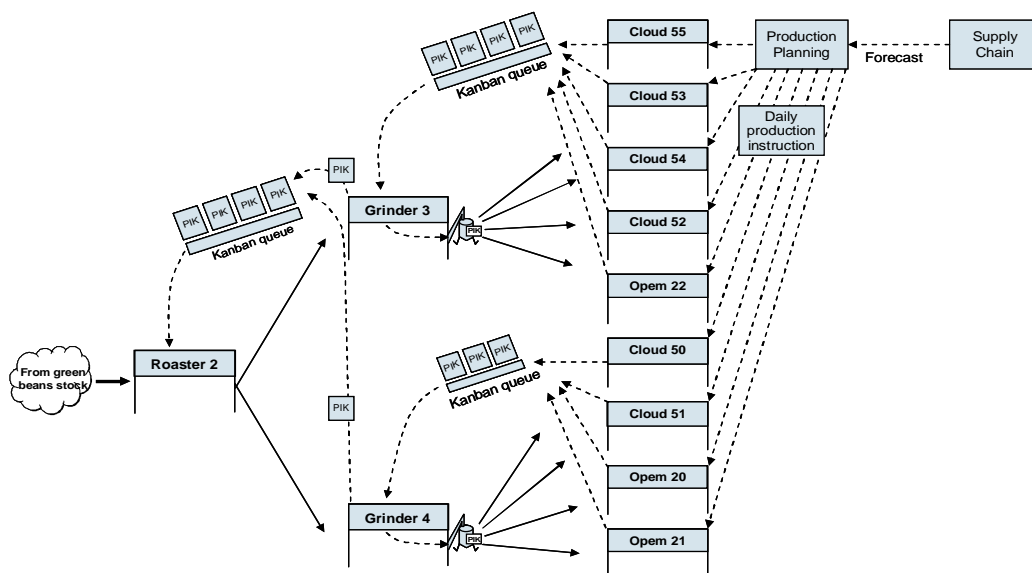

Figure 14: Senseo Value Stream (source: Grimbergen status report)



In mapping the value stream you identify and describe each action required to design, order and make a specific product or service. Next step and challenging is to sort these actions in three categories:

- First category contains steps which actually create value as perceived by the customer. Notice the direct importance to identify value from the customer's perspective.
- Second are the actions which do not create value but are currently required by R&D, order filling, or production systems and can not be eliminated just yet.
- Third and last category is those actions which do not create value as perceived by the customer. This last category should be eliminated immediately. Removing these actions would enable the company to work on the remaining non-value-creating actions (second category) through the use of flow, pull and perfection techniques.

Flow, pull and perfection will be described in the following paragraphs. Value stream mapping helps a company to see more than waste, it also reveals sources of waste in the value stream. A value stream map forms the basis of an implementation plan, it is the current state. It helps a company to design how the door-to-door flow should operate and becomes a blueprint for continuous improvement (figure 15). From this current state the ideal state can be designed. This state will be reached by small incremental improvements.

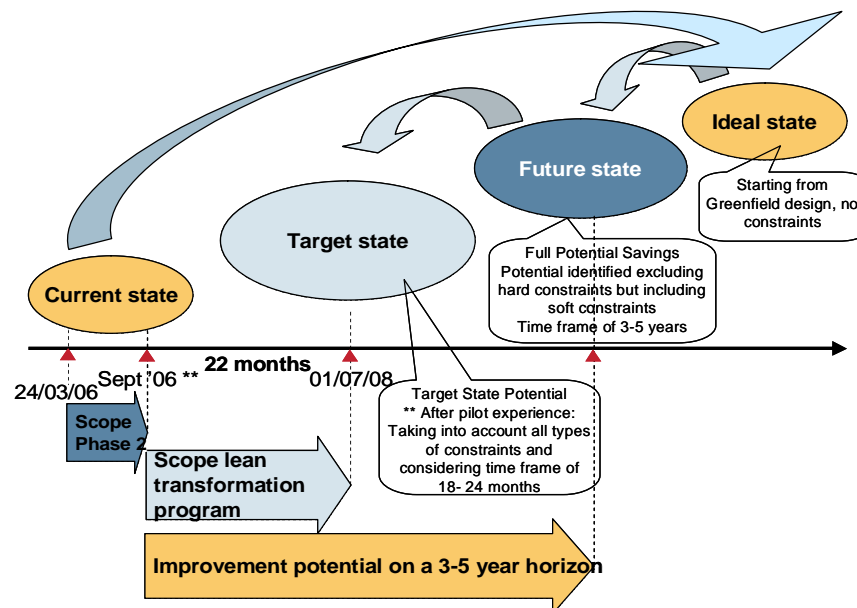

Figure 15: Current to Target State (source: CI strategy report)

### 3.1.3 Flow

Once value is defined and the value stream(s) have been mapped a company must start to make value flow. We live in a world of batch and queue, already loathed by Taiichi Ohno (Womack, 2003). For instance, if you go to a doctor you will have to make an appointment a few days ahead. After a few days waiting you visit the doctor at the appointed time but you will have to wait again in a waiting room. The doctor makes a judgment about what your problem could be and you are routed to the appropriate specialist. Once again you will have to make an appointment, and sit in the waiting room. You will be examined and from this diagnose further treatment will be routed. Perhaps you will have to come back or you will need hospital treatment. Probably you will enter another process of queuing and waiting. Glenday talks of a vicious circle which is driven by batch logic (Glenday, 2005). This vicious circle is shown in figure 16.



Figure 16: Vicious circle

Batch logic adversely affects people's motivation. It makes it hard to develop standard work, which is the basis of sustainable continuous improvement. Standard work is the most efficient way, to do the job that maximizes safety, quality, cost, schedule and customer satisfaction. It is focused on the actions of a single worker to produce a single piece of output (Kaufman, 2006). In batch logic, each time a batch plan is calculated it will generate a different plan. First because demand is variable, the actual demand will be different to the forecasted demand. Second reason is that only a subset of all the stock keeping units that could be produced are included in each batch plan. Batching causes ongoing customer service to suffer. It sub-optimizes efficiencies, resulting in more unplanned changes and fire fighting. Glenday states that a lot of companies have been stuck in this vicious circle for a long

time (Glenday, 2005). Despite every effort of their employees to resolve the symptoms and improve performance at all levels, their problems remain.

Perfect flow means producing and supplying at exactly the same rate as market demand. This is also referred to as levelled production (Womack, 2003) and is the foundation for the Toyota Production System(TPS). To achieve perfect flow in a company changes are needed in the production schedule based on large batches.

The starting point is batch logic, in which the biggest batch is produced in the longest run possible to minimize the number of changeovers and maximize the efficiency. A representation of such a schedule is production schedule A in the upper left corner of figure 17. This production system needs to change towards one piece flow, or batches of one. First by bi-monthly production, batches are broken in two and produced twice a month (figure 17, schedule B). Next step is to halve these batches again to create a weekly production run of each product. These weekly batches can be broken into batches produced every day. Finally these daily batches can be separated into batches of one. The resulting schedule E represents this situation.

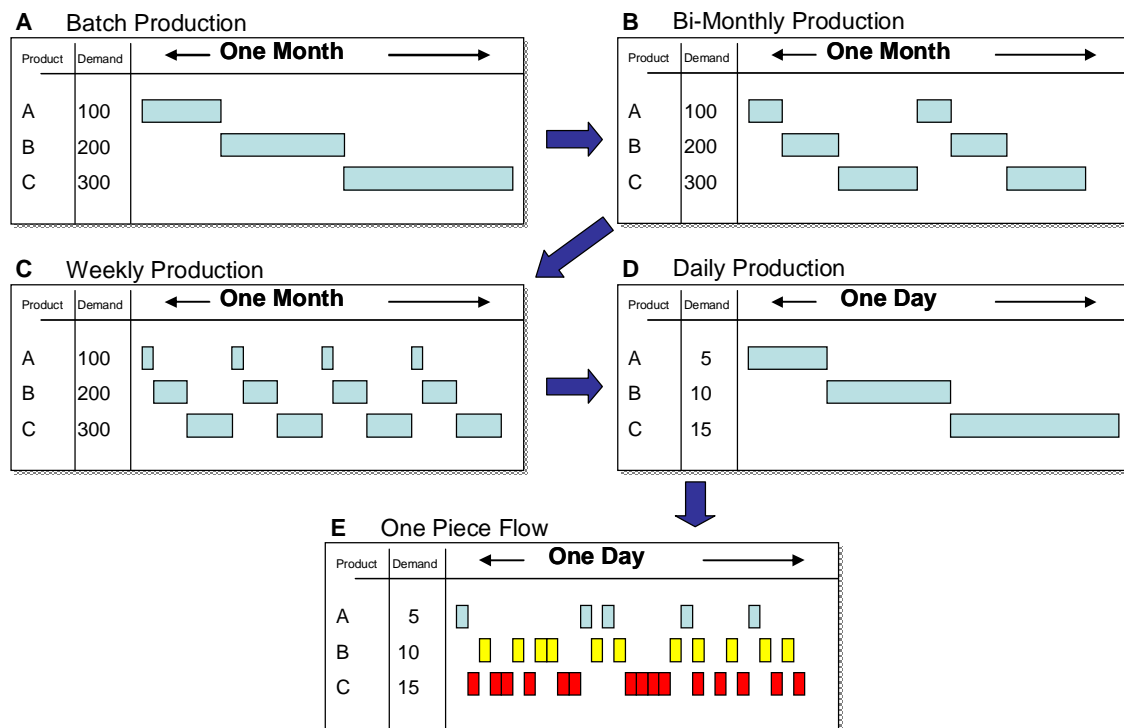

Figure 17: One Piece Flow

By using Every Product Every Cycle (EPEC) a company can change its production plan from batch production to daily production. The methodology of every product every cycle is a support structure to gradually implement one piece flow. If you just compare one piece flow to batch logic very often the batch logic system will end up as being the

cheapest. First reason is that one piece flow requires too much changeover time. Secondly the suppliers will not be able to supply smaller batches at the same price.

By using EPEC Sara Lee can slowly resolve these constraints. By using lean techniques a reduction of the changeover time can be reached. Applying lean and just in time at its suppliers will enable them to supply small batches at a competitive price. The final result is a more efficient production system. Besides this first positive result the production system will also be quicker and more flexible to react on questions from the market. This will help to create the fourth essential of continuous improvement, which is pull (paragraph 3.1.4).

EPEC can be used as a false bridge (figure 18) to support the initial start phase of mixed sequence one piece flow. If you compare EPEC to a keystone arch a structure to support the arch is built up. Only when the final stone, keystone is in place this arch is stable and the supporting structure can be removed. To come to perfect flow and mixed production sequence of one piece flow EPEC is the wooden structure to support the initial phase.

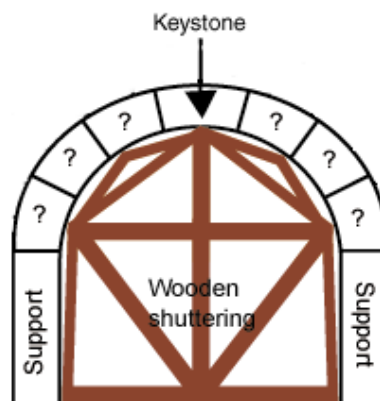

Figure 18: False bridge

However, EPEC is a push system with fixed sequence and volume. This push system is used to achieve the opposite: pull. The fixed sequence and fixed volume are used to get from monthly production to daily production. This phenomenon is called economies of repetition (Glenday, 2005).

Economies of repetition has three aspects.

- First is aid in creating a learning curve by getting better at tasks performed repeatedly.
- Second aspect is that an economy of repetition comes with routines. Employees are less stressed if their routines are not disturbed.
- Third aspect of economies of repetition is they help to create the environment where standardization can flourish.

Hard benefits of EPEC are that by using fixed cycles many other lean techniques can be applied more easily. Problem solving becomes easier because root causes are easier to identify. It helps to turn the vicious circle

of Glenday into a virtuous circle (2005). Every product every cycle provides a platform for sustainable continuous improvement. The virtuous circle is shown in figure 19.

A soft benefit is less stress because there is less fire fighting to be done. It clarifies responsibilities and reduces the need for management supervision. An environment for greater empowerment, more teamwork and better motivation can be created resulting in less required fixed costs.

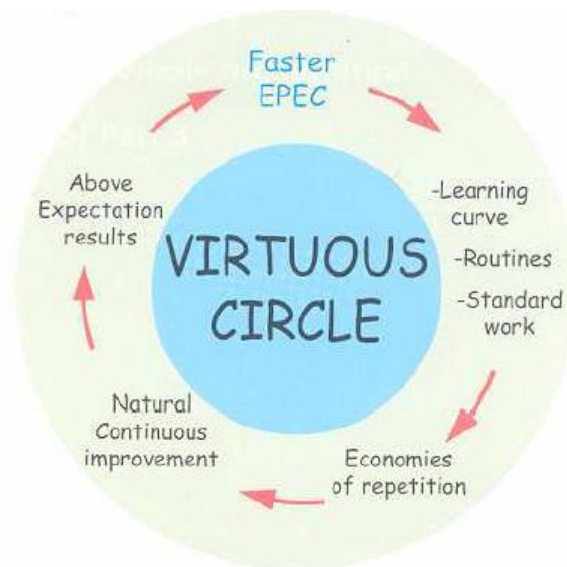

Figure 19: Virtuous Circle

Another advantage of continuous improvement systems over other business process reengineering practices is that a continuous improvement system can be introduced without disrupting the existing process. This is done by the model cell rollout (Swank, 2003). She advocates the use of a model cell which is an area where the company sets up a fully functioning microcosm of its process. A microcosm will allow managers to experiment and smooth out the kinks of a process and step by step work towards the optimal design, the ideal state. This approach has another advantage; it will excite other people in the organization about the process and the methodology. This paves the way for a broad transformation effort which is to come.

### 3.1.4 Pull

The fourth key principle of continuous improvement is called Pull. Creating flow was one step, the goal is to get a consumer driven supply network. Pull is an essential part of continuous improvement. It is about manufacturing only products that are pulled by the customer just-in-time. Flow is very hard to realize and only gets realized when products are pulled through the system. Several steps need to be taken to create pull instead of push in the system. First step is to reduce stock levels. A company must decrease the number of reserve bins in the warehouse and increase the number of active bins. A next step is to introduce standard work and visual control. Standard work is the most efficient way to do the job that maximizes safety, quality, cost, schedule and customer satisfaction (Kaufman, 2006). Visual control reduces the need for supervisors as everyone can look on the control board, see what is falling behind and provide some assistance. Along with the introduction of visual control comes another advantage. That is the ability to properly address the causes of disruptions. These causes can be solved by a kaizen, small improvement activity and by making use of performance management. Performance management will be discussed in the third paragraph of this chapter.

Posting performance results on whiteboards helps to encourage teams to set new performance records (Swank, 2003). At first reactions and feelings from employees will be very uncomfortable. Workers will fear that results will be used to punish and assign low performers. Employees grow accustomed to these boards and understand that they will be evaluated and rewarded for objective results they can track themselves, rather than by a subjective opinion from their bosses.

### 3.1.5 Perfection

The first four principles of continuous improvement interact like a virtuous circle. Just like the circle described in paragraph 3.1.3. This virtuous circle brings to the surface the muda or waste to be taken out of the system. The more value flows through the system the more muda is revealed and removed. As value is pulled harder more disruptions in flow appear and can be expelled. Product teams can get in contact with the customer to get to know more about specifications of value and enhance value, flow and pull. Strive for perfection by continually removing successive layers of waste.

## 3.2 Organizational change

A main concern in change processes is where does an organisational renewal process originate and how is it managed. Renewal can be defined as "the new way of thinking becomes day to day practice in the organization" (Savolainen, 1999). New realities, actions and practices must be shared so that changes become institutionalized. It is an incremental adjustment process which develops in small steps throughout the organization. The continuous improvement process looks like a cycle and not a single

straightforward process. It is a cyclical learning process. Starting with introducing ideas by upper management. Second step is propagating the ideas by middle management. Next is reinvigoration and improvement of the ideas. The ideological tone begins to weaken and a new drive is needed. The last step is spreading reinvigorated ideas. This process cycle seems to progress at different speed in different companies. Factors affecting this speed are resistance embedded in market labour systems or lack of gaining sufficient support. As a result change efforts tended to be abandoned.

The cyclical process tends to have two directions:

1. intensity
2. speed

Intensity is related to the manner carrying out the implementation and the content of training programs. It is related to the effectiveness and the visibility of innovation efforts. These vary by company. Speed is an indicator of the pace of development and is related to the degree of activity of disseminating ideas.

Savolainen argues that competitive advantages can only be realized if continuous improvement development managers understand the cyclical nature of organizational change (1999). Top management has a significant role in promotion of the ideology of continuous improvement. The middle management is in a key position in relation between supervisors and employees. Teaching the ideology and repopularizing continuous improvement theory.

### 3.3 Performance management

Companies all over the world have adopted numerous programs for performance management. Nevertheless these performance management programs would only in a risk free and static environment be functioning at their best. Sudden changes and disruptions harm their functioning. These systems provide mechanisms for relating company wide improvement policies to action at a local level. They concern product and process improvement policies which are developed by upper management and need to be translated to local organizational levels. A research by Bond (1999) describes a process life cycle in four stages:

1. process maintenance
2. process improvement
3. process re-engineering
4. achieving stability in the process

Process maintenance can be done by using kaizen activities to identify small problems and solve them on low cost scale. Kaizens arise bottom-up and sometimes spontaneous largely outside control of upper management. Process improvement is the next step as only the first step, process maintenance, is the minimum that is required. Improvement can be done by

using Deming's virtuous circle of Plan-Do-Check-Act, also called a PDCA circle (Bond, 1999). These phases refer to setting a new target in the Plan phase. The implementation of this plan is done in the so called Do phase. The last two phases are installed to make sure the desired plan is achieved and an action is taken if needed to correct errors. No incentives are used; continuous improvement relies on doing a good job as driving force to improve current processes. Process re-engineering is described by Bond (1999) as a great leap forward. Instead of improving on a continuous basis this step focuses on the increase of competitive results by involving customer, process and products. It proceduralises double-loop learning into a central management policy. Double-loop learning is characterized by challenging the fundamentals of products and processes. The final phase is regaining stability after phases of change. This can be done by using a set of qualitative measures. Critical is to provide accurate documentation on new processes and products. The continuous improvement process moving from value towards perfection can start again.

### 3.4 Conclusion

In this chapter I presented the theoretical background of continuous improvement. Continuous improvement is the remedy for waste. Applying continuous improvement allows a company to provide almost exactly what the customer wants in the right quantity and the right time. To be able to do this a company has to focus on the five key principles of continuous improvement.

1. Value
2. Value Stream
3. Flow
4. Pull
5. Perfection

These five elements together are the basis of continuous improvement. Although they all have to act together the second one is actually the most critical (Rother, 2003). The value stream forms the basis of an implementation plan. The value stream map is the depiction of the current state. From this current state the ideal state can be designed.

I have also argued that it is important to understand the cyclical way of learning in organizational change. The ideas to change the organization come from top management. They have to back the ideas and understand the methodology of continuous improvement. This creates the necessity for a clear training structure. The middle management has to propagate the ideas in the organisation. Line management and employees have to understand the ideas and provide ideas for improving their situation. These ideas have to be picked up by higher management again.

Changing the organization is only one step. After organizational change the processes have to be stabilized. Bond describes a process of planning a change. Implement the change and check if it corresponds with the plan. In the last step changes can be made again. These can be adjustments or starting another cycle again. Continuous improvement does not work with



---

incentives; it relies on doing a good job as driving force to improve current processes.

In the remainder of this report I will check if there is a good focus for these three critical points. I will check if there a good structure available to identify the value stream. Besides good values stream mapping a training program needs to be on hand. All the employees from top management down to the production employee operating the machine on the line need to be trained on continuous improvement tools. This training material needs to be available in the organization to create an open structure for learning and improving. A third aspect in the framework is the need for accurate performance management. Bottom up ideas have to be managed and performance results must be posted. The organisation can track its own performance and will set new performance limits.

## 4. Future state

In this fourth chapter I describe the proposed new situation. To create this future state a clear hierarchy structure had to be created. This hierarchy is discussed in paragraph two. To report to the PMO team the SmartTool is used. It is explained in the third paragraph and the changes which were needed for managerial control. The fourth paragraph is focussing on the process of continuous improvement. To prevent employees from reinventing the wheel common processes have been created. In the last section of this chapter I will discuss the training part. The five levels of continuous improvement training are explained and I will clarify how these figures are consolidated through the organization.

### 4.1 Intranet environment

The conclusion of chapter two was that a special continuous improvement site for Sara Lee International was needed. Sara Lee International is an organization with different business segments. A division is made between Operations, divided in manufacturing and supply chain and Non-operations. In the continuous improvement projects it is necessary to keep this in mind. A distinction can be made between these business segments. By examining the current state it became apparent that a special continuous improvement environment on the intranet is needed for Sara Lee International.

Using CI tools helped me to create an image of the current state. This is done in chapter two of this report. From this current state I was able to create an ideal state. From this ideal state the target state can be created. This approach is in line with the methodology shown in paragraph 3.1.2 figure 15. It resulted in a depiction of the InSite environments and the challenges ahead of the CI PMO team. The overview of sites is shown in figure 20. In this overview of sites there is also a special cell referring to the SmartTool. I will discuss the challenges concerning this part in the third paragraph of this chapter. For Sara Lee International a special CI page will be developed. This was a result of the current state analysis which I described in the second chapter.

One issue still left open are the project charters. Currently this relatively static information is located on the SLC CI page. Where should these be located for the SLI initiatives? The charters are meant for upper management to see the progress of initiatives in percentages complete and stoplight criteria. Creating the charters for SLI on the SLI page will lead to a small mess. Charters are located on the SLC page and others are located on the SLI page, which is one level lower underneath the SLC page. If located in two places some managers will not be able to find the information as they suppose it will be stored in one place. Therefore all charters will be located in one environment on the upper layer, the SLC CI page on InSite. Initiatives

form Sara Lee International will be marked with SLI in front of the initiative name. The charters from Food & Beverage and Foodservice are also being marked so that sorting is possible.

Good performance management is enabled if clear cycles of PDCA can be performed. The information to perform these cycles within an initiative needs to be clear on hand. I argued that the SLI initiatives have to be provided with team sites. These team sites can be used by the CI Facilitator for reporting to the CI Department on one hand. On the other hand, probably even more important is the special space of a team site which provides a space where teams can combine idea management and performance tracking, two examples of performance management.

In figure 20 the SmartTool is connected to SLI intranet environment. I have done so for the reason that connecting the SmartTool to the InSite environment provide another opportunity. The data from all SmartTools can be exported to Excel and is ready to use for analysis via pivot table or other functions of Excel. The data file can also serve as an upload to SLC environment.

### Total Overview Sites and Smart Tool with Main Issues / Challenges

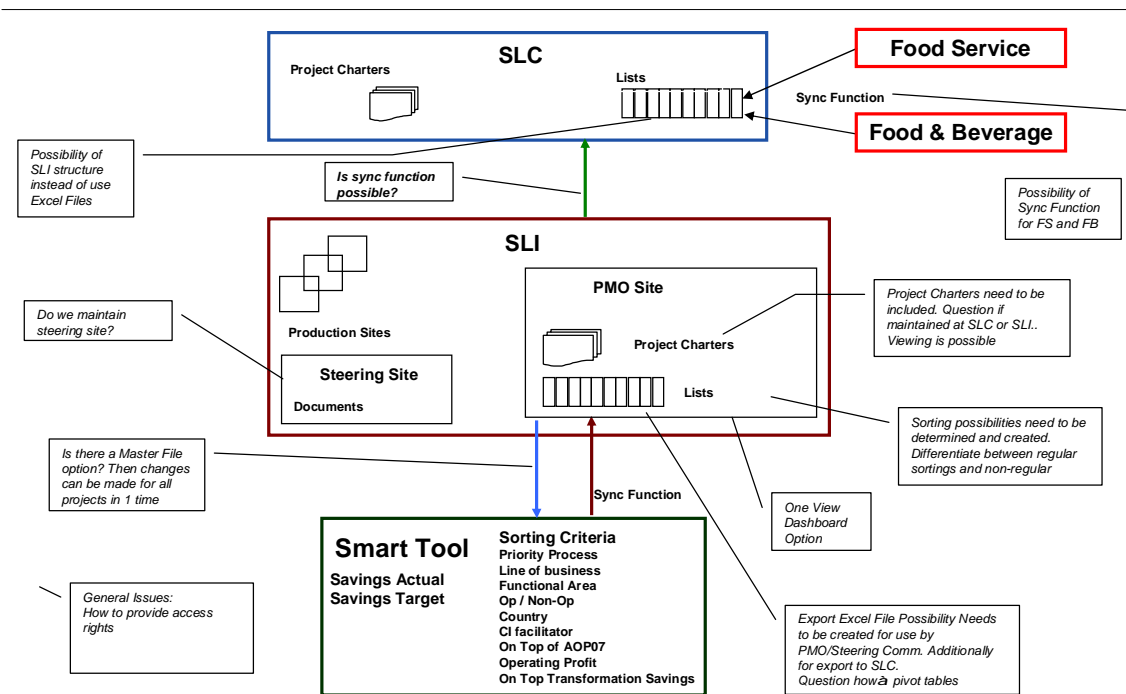

Figure 20: Sites & Issues

On the SLC page the challenge is to create a synchronise function to upload data from SLI environment to the co-ordinating SLC CI page. Currently data from Food service and Food & Beverage is stored in lists of Excel files. What

are possibilities for SLC to adopt to the SLI structure with one data storage. This question is a question to be answered by employees of the US based company. The task of the goal of this assignment was to focus on Sara Lee International. A general issue is the access right to the different sites. As Kerrin (1999) stated, continuous improvement is not only a bottom up analysis, it has also many top down lines through the organisation. Private sites and limited access rights do not contribute to an open environment for continuous improvement. The different sites should be kept as open as possible. All training material, CI tools and data would be accessible for the employees with a differentiation in rights to upload or modify data. A distinction is made for reader, contributor and site owner respectively with growing number of opportunities.

## 4.2 Hierarchy structure

Theories and studies on LEAN and continuous improvement are much focussed on Manufacturing. Sara Lee International also wants to apply continuous improvement to its non-operations department. Continuous improvement terminology is about value streams and creating pull in production lines. In the Senseo coffee plant in Grimbergen it is obvious to describe the production of a Senseo coffee pad as a value stream. The line could be machine number 11 producing the pad. In non-operations it is more difficult to describe the value stream or the line. A clear separation and distinction of hierarchies had to be created to prevent a fussy mess in the continuous improvement organization. Without a clear hierarchy structure it would be almost impossible for CI Facilitators to report progress and savings to the CI department. It would even be a harder job for the CI department to report figures to the board of management, and to consolidate numbers. It would be unclear from what level the numbers appeared and in how much detail work and processes are analysed.

To set up a clear hierarchy structure I identified the initial hierarchy applied in Sara Lee Internationals operations division.

The structure is drawn in figure 21.

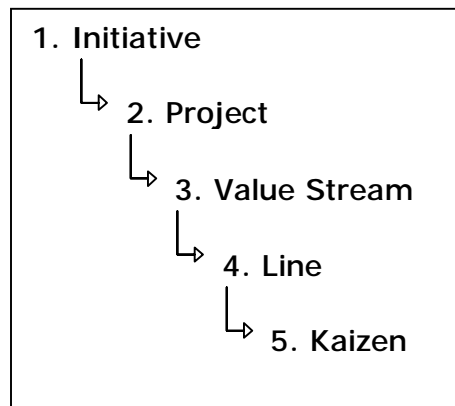

Figure 21: Old Hierarchy

As mentioned above level three and four are much more difficult to describe for non-operations. What is a value stream for the Human resource department? Is that Human resources as a whole or the process of hiring an employee? I concluded chapter three by highlighting that the value stream is the most critical key element of continuous improvement. In a clear hierarchy I mentioned the special place for the value stream. The map of the value stream is the basis for the ideal state and the rest of the CI process. By brainstorming within the PMO team and interviewing CI facilitators from different fields of expertise the following hierarchy structure was built (figure 20). First the Initiative level was left out, and the value stream would be a total factory. However, in a factory there are several different processes going on. For instance the Senseo coffee plant Grimbergen has three value streams Senseo, Anvar / Whole bean and DeVac (appendix A). By defining the total plant as a value stream I argued that the remaining underlying production lines and machines would not be able to be defined in a proper way. The hierarchy structure in figure 22 is fitting for operations and non-operations. This creates a clear vision throughout the whole organization. The lowest level in the old hierarchy was dropped. The argument to do this was based on the fact that a kaizen is more of an activity instead of a hierarchy level. Kaizens are main drivers for continuous improvement. Dropping it from the hierarchy structure did not mean a farewell to this key element. It is in close harmony with the total structure and added to activity management. A kaizen can take place in different levels of the hierarchy structure. In the Senseo coffee plant Grimbergen a kaizen is setup like a Deming circle. The phases of plan, do, check and act, figure 22

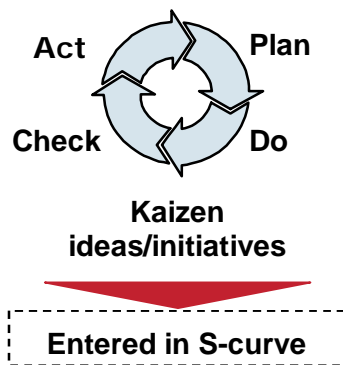

Figure 22: PDCA cycle

The lowest level in the new structure has become sub-process for operations, sub analysis for non-operations. I choose the name sub analysis because in Non-operations you focus on a special value stream and take a closer look at the value stream in one country. I called this an analysis instead of a closer investigation on one machine in Operations, which I have called a sub-process. In the new hierarchy structure Sara Lee stopped using the name Line. The reason for this has been mentioned earlier in this report: What is a

line for innovation or human resource. The new hierarchy structure is it shown in figure 23. This figure will be discussed below.

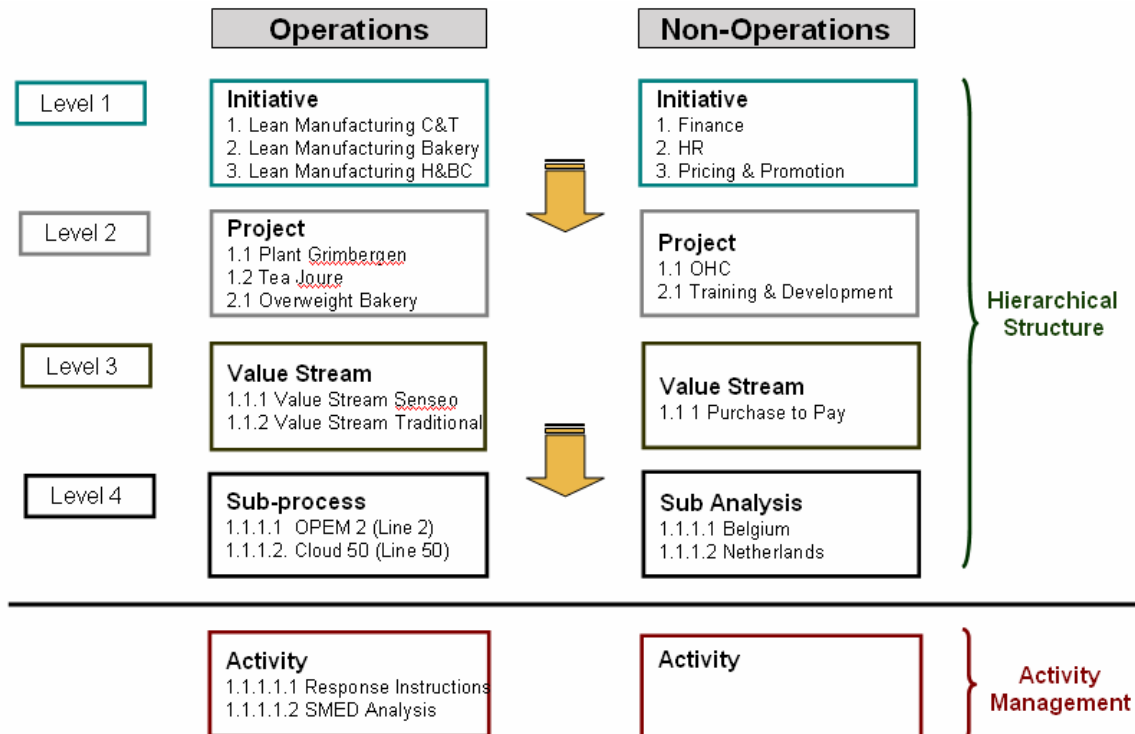

Figure 23: New Hierarchy

An initiative is the consolidation level of one or more projects. It should deliver at least €500.000 annualized savings. An initiative in manufacturing is the lean manufacturing coffee & tea (C&T), bakery or household and bodycare (H&BC). Such an initiative encapsulates all projects within bakery, C&T or H&BC. In non-operations the Finance department is an initiative, likewise HR, Pricing and Promotion and Innovation departments can also be marked as an initiative.

A project is the consolidation of one or more value streams. It is focus on a plant in operations or functional area in non-operations. A project is used to tackle waste, muda and variability in one or more value streams. The running example, the Senseo coffee plant Grimbergen is a project under the initiative Lean manufacturing C&T. In the non-operations finance initiative a project is optimization, harmonization and consolidation of financial processes (OHC). A project is the lowest level for reporting to Sara Lee Corporate. Within the projects value streams exist. A value stream in operations is the sum of actions, both value creating and non-value creating, required to bring a product from concept to launch and from order to delivery.

A value stream for non-operations can be described as the sum of all actions both value creating and non-value creating for a service to meet customer

requirements. This customer can be an external company or consumer but it can also be an internal customer. In finance the process from purchase to the actual payment of the bill is a value stream. Another value stream in finance could be order to cash. This maps the process from an actual order as starting point towards the payment by the customer.

The sub-process in operations is a series of individual operations that occur in a specific sequence to produce a product. A sub analysis in non-operations is a series of individual operations that occur in a specific order to design and complete an order or to perform a service. Sub process and sub analysis are the lowest level in the hierarchy.

The activities do not belong to the hierarchical structure. An activity is a specific action in order to deliver improvements in the hierarchy structure. It does not have to be a continuous improvement workshop (CIW) or Kaizen. It could very well be another continuous improvement tool like SMED, Six Sigma or Sipoc.

The hierarchy structure also provided the ability to setup a clear structure for the data reported on each level. As mentioned before Sara Lee International uses S-curves to graphically display the performances. With the new hierarchy structure I was also able to display the S-curves for each level (figure 24).

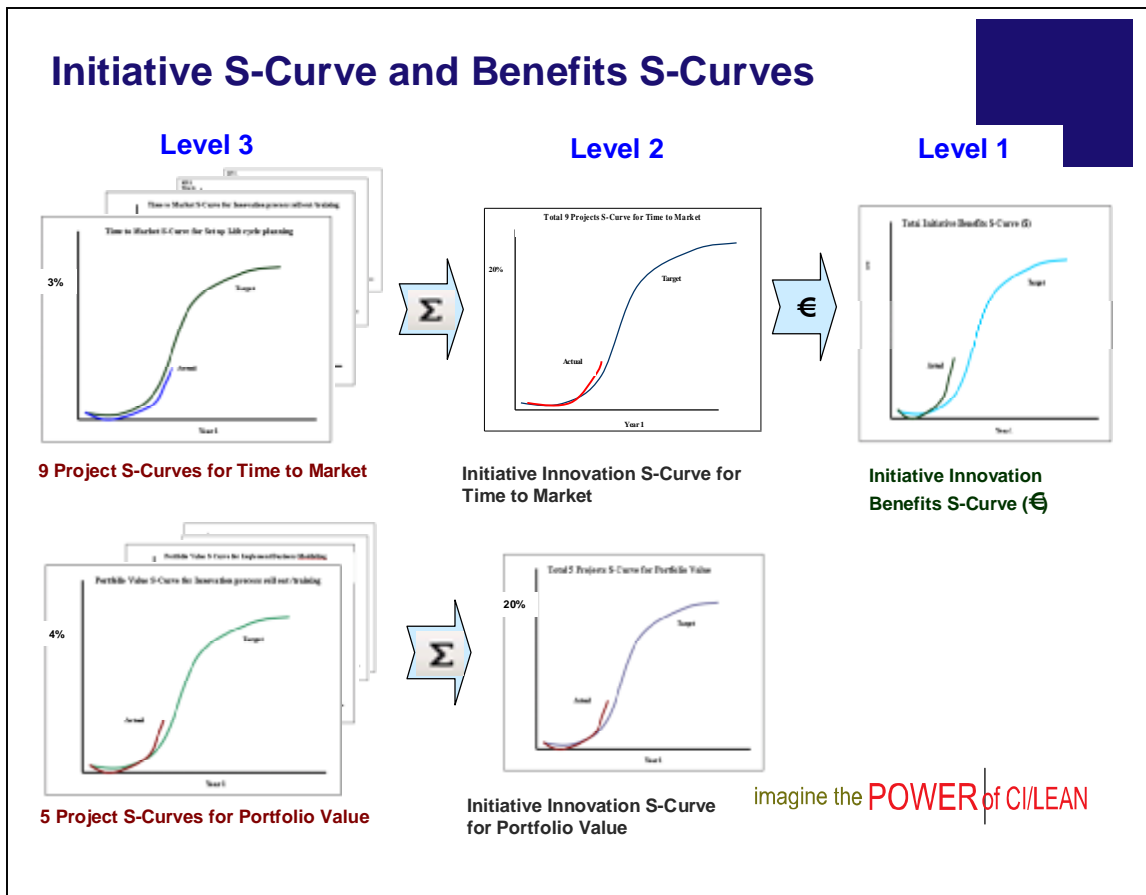

Figure 24: S-curves on different levels (source: CI Facilitator training)

### 4.3 SmartTool for reporting

As stated earlier in this report continuous improvement has to become a part of the organization. The timeline for the project management office to report on continuous improvement results is set to a maximum of two years. The end of fiscal year 08 will also mark the finish of the PMO team. For financial reports an expensive system can be bought or modified. Sara Lee International makes use of SAP and Hyperion. However these systems are not introduced and running in every country. Licensing a total country and modifying business procedures to fit such a system would cost a great amount of money. Secondly it would take a lot of time to get these systems implemented and running. That time horizon would probably be bigger in comparison to the timeline set for the CI department.

For these reasons a solution much easier to implement was sought. As PMO team we found the solution by using MS Excel. Already in use in Sara Lee plants was the SmartTool. This tool creates the ability to report for a project on different issues like lean development, operating profit and savings. Key performance indicators can be chosen by a CI Facilitator. The KPI's can be tracked using the SmartTool. Data input can be given in the SmartTool fields to track the KPI's on a local level. The SmartTool facilitates in creating graphical displays of current performances very easy. These can be printed for visual management on whiteboards. This will encourage teams to set new performance records and improve on a continuous basis. They keep seeking for ways of doing this better (Swank, 2003). The graphical displays are easy to interpret for quick reactions. How much KPI's does a CI facilitator need to check? In an interview with the VP continuous improvement non operations he argued that only a handful of KPI's were desirable. Indeed, for quick hands on management and steering a limited set of figures was desirable. The CI Facilitators agreed on his opinion. In a conference call with all CI Facilitators I proposed to limit the traceable number of KPI's in the SmartTool to five. A second reason was to prevent the CI Facilitator from tracking too much data. This data would not weigh up to the extend of effort used to gather the data. It would take a lot of time to gather data and the result would be minimal.

The CI Facilitator can carefully select five KPI's to track and these will be entered in the SmartTool setup. This SmartTool setup is specific for every CI Facilitator.

Using the SmartTool starts with setting targets for the project by the CI Facilitator. The targets are set for the entire timeline of the project. Before setting this target a pilot will be held to identify the possibilities within a project. Secondary to the targets the CI Facilitator will report actuals in the SmartTool. The actual figures will also be displayed in a graphical display. Together with the defined target this provides a quick overview of the project status. A third functionality is the ability to report your plans in near periods. Numerous plans can be entered; in addition the financial benefit of a plan can be specified. In the SmartTool using the S-curve functionality these plans can be made visible. The result is an image of a target line, an actual line and columns or bars which represent the future plans. If a bar does not



reach the forecasted plan it is obvious for the CI Facilitator to take action. More effort in continuous improvement is needed to reach the ideal state in time.

A bar shows the CI Facilitator four kinds of information about future plans: Started plans, approved plans, current ideas and the worst part, no ideas yet. An example of an S-curve is shown in figure 25.

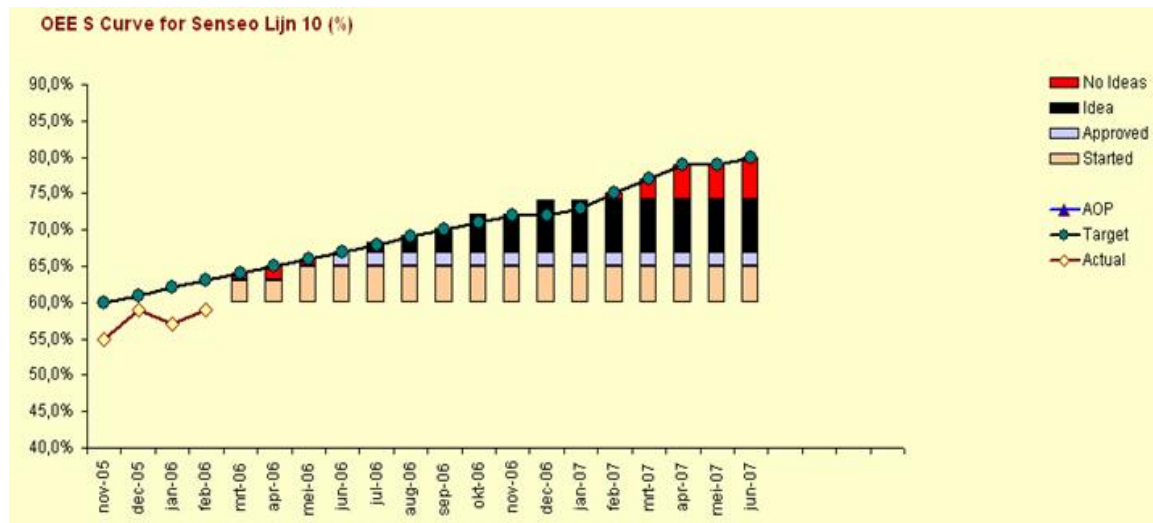

Figure 25: S-curve from SmartTool Grimbergen

This example shows an S-curve for improving the overall equipment efficiency (OEE) on Senseo line 10 in the Grimbergen factory. On the x-axis the periods are depicted and the efficiency is set out on the vertical axis. As from February 07 this picture shows that there will be a gap of having no idea to reach the target. The CI Facilitator will see the need to get the team together to prevent from falling behind.

#### 4.3.1 Managerial control

Sara Lee International is a bundle of different brands and categories. As a result the organization is operating in different experts fields. Good managerial control by the CI Department makes it necessary to have the ability to dig in on certain areas, countries or persons. To be able to do this the managers of the CI team and other upper management have several options. Project charters can be sorted on spotlight. The three colours will easily let the manager draw the conclusion where support or additional steering is needed. The milestone management will enable the CI department to see whether an initiative reaches the milestones set at the beginning. The SmartTool will be used by a CI facilitator on his local level. To get this data available for the CI Department all SmartTools could be mailed to the CI PMO Team. However this would create a lot of work for an administrative person to collect and upload the data. I proposed for the new situation that data from the SmartTool will be synchronised via a sync button to the SLI CI environment. To prevent the synchronisation file of becoming a

large data dump with figures from all projects all over it this data has to be structured.

A new feature has to be added to the SmartTool. The SmartTool should be upgraded with a possibility to sort the data in different ways. As I link the SmartTool to the InSite environment the sort fields on InSite need to be a match with the sort fields in the SmartTool. The list in the SmartTool has to be an exact match with the list on InSite. I will explain the sort options in the remainder of this paragraph. A summarization is shown in table 3.

Extra sort fields needed	
Priority Process	Figure 26
Line of business	Figure 26
Functional Area	Figure 26
Country	Figure 26
CI Facilitator	Name
On top of AOP 07 benefits	Yes / No
Operating profit	Yes / No
On top of transformation savings	Yes / No
Operations / Non-Operations	O / N-O

Table 3: Sort Fields

Priority processes are identified as critical. They have the potential for Sara Lee to outperform its market competitors. It is therefore obvious to have a sort possibility on this element. To create a sort on priority process we added an area with a list of the priority process. Within Sara Lee five priority processes are identified. These processes are marked as highly important as they will provide Sara Lee with a competitive advantage over competitors in the market.

To sort on Line of business a list of the three line of businesses had to be created. For an operational process it is often quite clear in which line of business it is situated. In non-operations it is much more difficult and very often not even possible. For Sara Lee International three line of businesses exist: Coffee & Tea, Household & Bodycare and Bakery. To design a solution non-operations a fourth option was added, Multiple.

As a result of adding multiple to the field Line of Business the sort on functional area another list had to be created in the SmartTool. If this functional separation would not exist a lot of information would end up together. To create a division in this information in the SmartTool a list with functional areas of Sara Lee has been added to the master data.

The sort on country is based on the name of the country. This list is the longest list, however not all operating countries of Sara Lee International are present. As some countries are rather small they have been put together to form a region.

CI Facilitator is a selection field in which the name of the CI facilitator has to be selected. All names of CI Facilitators are known to the PMO office and the CI Department as the CI Department has organized the training sessions for the CI Facilitators.

The sort for On top of AOP 07 benefits and Operating profit are based on Yes or No.

Some of the continuous improvement projects are also reported under transformation, this means that the projects report parallel in both environments. To prevent a double count, we have created in the smart tool request form the field On top of transformation savings Yes/No, so that we know not to double count for the profit and loss statement. Almost the same applies for the last sort field. This is not a Yes or No selection but a choice for one out of the two.

To create these sort fields in the SmartTool I have to modify the master data of the SmartTool. The master data is a separate sheet in the excel file, hidden at the back. Some fields can be modified by the local user, the CI facilitator. The majority of the cells contain setup information this information is robust and marked by a red colour indicating that it does not need to be changed. White cells indicate that changes can be made by the PMO members. These cells are password protected.

Priority Process	Functional Area	Country
Business Planning	Finance	Asia
Customer Management	Global Sales	Australia
Innovation	Global Brands	Belgium
Price & Promotion Management	HR	Brazil
S&OP	IT (Slice)	Czechia/Slovakia
None	MSU	Central Eastern Europe
	Manufacturing	France
	Procurement	Germany
	R&D	Greece
	SLIF (MSU)	Hungary
	SLIF (Operations)	Iberia
	Supply Chain	Italy
	Other	Netherlands
		New Zealand
		Nordic
		Poland
		Russia
		South Africa
		Switzerland
		UK
		USA (H&BC)
		Other

Figure 26: Lists for sorting

#### 4.4 Common Processes

In continuous improvement methodology I remarked the importance of standardized procedures. As such the PMO office has been searching for a standard process of implementing continuous improvement. How would a continuous improvement facilitator best perform and transfer his knowledge to the employees. In manufacturing the process is a visible value stream easily giving insight in possibilities for improvement. A non operations process is much more difficult to observe. The process of continuous improvement can roughly be depicted as I have done in figure 27.

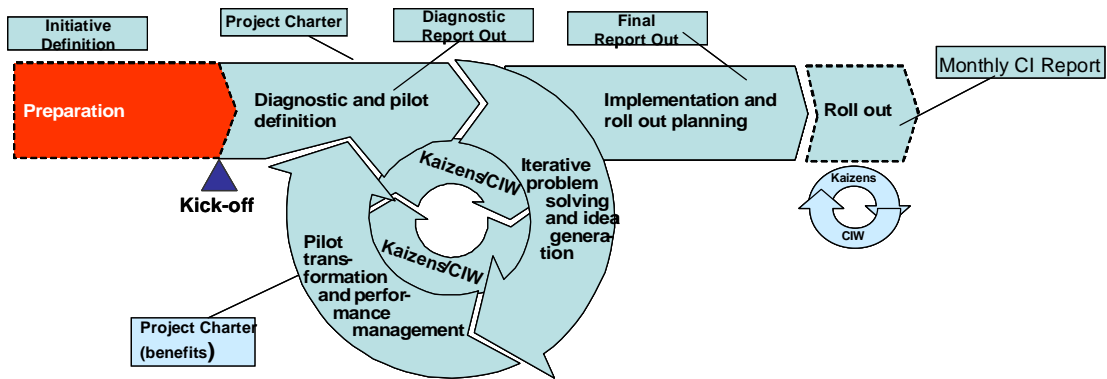

Figure 27: Continuous Improvement process

It starts with the preparation and uses a cyclical process to end in a roll out phase. This cyclical way of learning and improving is related to the theory of Savolainen. Small incremental steps are used to improve the processes. (Savolainen, 1999). To create stable processes and settle the organizational after a renewal process Plan Do Check Act cycles are used. These cycles can be used at any time and will open new opportunities renewal process. A cyclical improvement starts as the basis for continuous improvement. (Bond, 1999). Within Sara Lee International the above process has been described for operations and non operations. The latter one will be described in the next part. The continuous improvement process for operations will be discussed afterwards.

#### 4.4.1 Non-operations

I designed a common process for continuous improvement. In the process the cyclical way has to be included. The PDCA cycles will be performed in the CI Workshops. The structure supports implementation as well as reporting. During every step different tasks are important. I will describe the process and highlight the important procedures per step. The steps in the non-operations process are shown in figure 28.

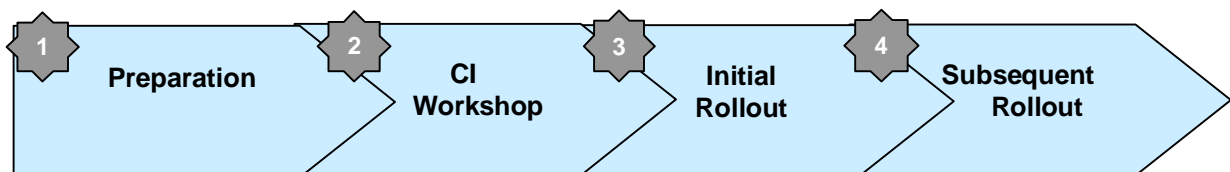

Figure 28: Non-operations process

Projects within non-operations are differentiated into four different phases. The process starts with a Preparation phase and ends by Subsequent Rollout as shown in the figure above.

In each of the respective phases there are different reporting requirements. The process starts only when project is approved by VP continuous improvement and the Board of Management.

Phase one, preparation of the project incorporates two important activities. For correct administration the PMO will ask the CI Facilitator to provide additional project information such as project name, contact persons and contact details. The PMO team provides access for these persons to the CI Support site where documents concerning reporting requirements can be found. The second activity in phase one is the creation of a project charter. For each project a new project charter has to be created on Sara Lee Corporate InSite environment. The PMO creates a new charter format under a specific initiative with the desired project name, as mentioned by the CI Facilitator. The CI Facilitator is asked to provide and fill in all managerial items. At this moment the CI facilitator is not yet asked to provide the figure for Expected Financial benefit. This figure is only known after the CI Workshop has been completed. An example of the project charter is shown in appendix C. To explain how to create a project charter and instructions about filling in the fields the PMO created a CI Tooling manual which was placed on the SLI CI support site

Phase two, the continuous improvement workshop (CIW). A CIW is a workshop with duration of four to five days. A CI Facilitator organizes a CIW to analyze the current state of a process, for example 'sourcing and selection' in Human Resource department. How to get from an open position to a signed contract.

This step is a very important step and therefore I have made it a separate one. Why is it so important than? This step creates the essential value stream map needed for the rest of the process. For instance in the HR CIW, employees of different countries gathered together in a physical meeting. They all described their current process on a sheet of brown paper. From this current state (sometimes differing per country) the ideal state will be designed by people who work in the process day by day. This word "ideal" is later on removed from the paperwork and replaced by future state. This future state becomes the goal towards the team will start working by standardizing processes and implementing best practices by aligning businesses. In essence this is the process also described in paragraph 3.1.2

A CIW is closed with a report out. This standardized document contains the (several) current situation(s), results of analysis, steps to be taken either directly or future steps, needs of the team and standardization by using lean tools.

To facilitate a team formed in a CIW the PMO creates a Team Site. The CI Facilitator must determine whether he wishes to establish an "initiative" team site (shared with his CIGL/CICA colleagues) or one site specific for his project. The team site can be used for sharing documents and communication within the project team(s). Figure 29 shows a screenshot of a team site.



Figure 29: Team sites example (source: team site Grimbergen)

The PMO team provides access to the team site and sends a manual on how to use the team site. The InSite Support Team will contact the CI facilitator for additional support on how to customize the site and use it in its full potential. The CI team site must be managed and organized within the standard template. This idea is mainly driven by the need of clear and easy accessible information. Another functionality of the team site is reporting. The Report Out and CI Progress Reports have to be uploaded from a local pc drive to the team site. The team site has the functionality to concurrently show these documents on the CI PMO site. Again for explanation 'how to' the PMO provided a CI tooling document.

In case of a large project it can be required to report the findings of a diagnostic in a Diagnostic Report Out. If this is required the CI Facilitator will be notified by the continuous improvement VP or Director. The diagnostic report out can also be reported through the team site as described above. The format for the Diagnostic Report Out is a standard document with a predefined layout. The standard format is used to increase the level of insight for non team members.

Before roll out, phase three is the Initial Rollout where a SmartTool Request Form has to be filled in. This request form provides the PMO team with project characteristic information necessary for creating a unique SmartTool. As described earlier the SmartTool masterdata worksheet contains cells marked by a white colour which can be modified by the PMO team. The SmartTool request form is available for all CI Facilitators on the Sara Lee International CI support site. In appendix D an example of a filled in SmartTool request form is presented.

The SmartTool request form asks the CI Facilitator for specific project information. This information is related to the sort options created in the SmartTool. The example shown in appendix D requests the fields which relate to name of initiative and name of the project. It also requests the line

of business, the country and the priority process and the functional area. In these last four requested fields the options can be selected from a scroll down menu. Preventing mistyping or a creation of various names by the CI Facilitator.

After the CIW the Final Report Out needs to be reported. This is the final version of the report out written and presented at the end of the CIW. The document can be uploaded to the PMO site through the functionality of the team site. When all these steps are taken updating the expected financial benefit of the project is possible. During initial rollout the Future State (target Benefit) has to be defined. When the Target Benefit is known the project charter has to be updated on SLC InSite with the Expected Financial Benefit in \$. This figure is the project-to-date financial benefit for end of the next fiscal year. For example: if the project starts in FY07 the CI Facilitator should report the Target Benefit from the start of the project to end FY08. Also the project phase has to be updated.

The last phase is called Subsequent Rollout. In this phase the SmartTool will be sent to the CI Facilitator by the PMO. As member of the PMO office I organized two training sessions in October and January to train all the CI Facilitators on how to work with the SmartTool. The CI tooling manual regarding how to use the tool is made available on the SLI CI Support site. This phase and using the SmartTool ensures performance measurement is done by the CI Facilitators. They will set targets and then check if targets are reached by measuring the actual. If there is a visual gap in an S-curve between target and projection of ideas the a PDCA cycle can be used to resolve the gap and even perform above the targets set earlier.

Project benefits and operating profit input in the SmartTool is used for SLC financial reporting. Operating profit is defined as all continuous improvement changes which have an impact on the profit and loss statement(P&L). The project benefits are the balance sheet, the KPI impacts as well as the operating profit impact. The project benefits can be equal to the operating profit impact, in many cases the benefits will be higher then the operating profit impact.

In all circumstances the CI Facilitator should speak to the PMO office to agree on the content of target and actual data to be recorded before any upload of data through the SmartTool. The target benefit and operating profit have to be populated up to end of the next fiscal year, currently that is FY08. If the project ends before the end of FY08, the financial figure of the last period must be extended. This results in a straight line, copied to the end of fiscal year 08. Also the respective annual operating plan has to be populated. If the project results in Operating Profit the CI Facilitator must also report Benefits. To upload the targets and annual operating plan values directly to SLI InSite the SmartTool has been linked by the PMO team to InSite and the Sync function will upload the data.



#### 4.4.2 Operations

For operation processes at Sara Lee International I wanted to use the same CI process. However I have chosen for six phases instead of the four defined in non-operations (see figure 30 below). Reason for this is the substantial bigger projects in operations regarded to non-operations.

In operations I have defined a factory as a project, see also the hierarchy structure in the second paragraph. In such a project the value stream in operations is better visible but in this value stream there are a lot of small steps, buffer zones, stocks and machines to analyse. Analysing the value stream will take more time and requires a special report out. This explains why I have chosen for the extra diagnostic and pilot definition in phase 2. In each of the six respective phases there are different reporting requirements. I will describe what steps to take in each of the six phases, and point out what kind of reporting is required, how to report and where to find support.

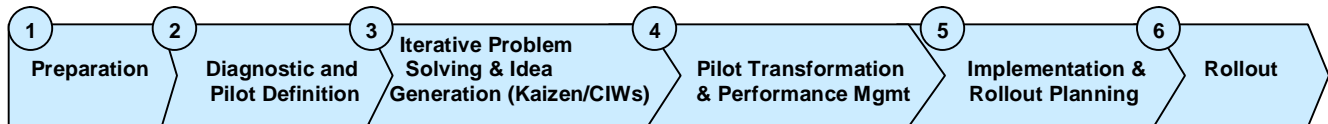

Figure 30: Operations process

Phase one in operations is in a sense a copy of phase one in non-operations. For correct administration the PMO will need to ask the CI Facilitator for project information such as project name, contact persons and contact details. The PMO office will create a project charter (appendix C) on the SLC CI page for each project under a specific Initiative with the specified project name. The CI facilitator is required to fill in the fields of the project charter.

In phase two the CI Facilitator runs a diagnostic on his project. This phase starts with a detailed waste analysis. A bottom up analysis in which all muda is identified. The focus on waste reveals new horizons and changes the way of thinking. This phase results in a future state operational system. As a result of the thorough analysis this second phase defines the total improvement potential. The CI Facilitator has to determine whether he wishes to establish an “initiative” team site (shared with your CIGL/CICA colleagues) or one site specific for the project, see figure 29 for an example. This team site can be used for sharing documents and communication within the project team(s). The PMO office will provide access to the team site and send a manual on how to use the team site. In companion with this support document the InSite Support Team will contact the CI Facilitator for additional support on how to customize the site and use it in its full potential. The CI Team sites in operations will have a common structure and must be organized in a standard template. This makes all different team sites accessible for visitors. The team site is also to be used for reporting issues. The Diagnostic Report Out and CI monthly status reports have to be uploaded into the team site and they will be available concurrently at the CI

---

PMO site. This feature of the team site is described in the CI Tooling manual as well as the Team Site manual. These manuals are available on the PMO support site.

Phase three and four concentrate on iterative problem solving. This is done by setting up pilot transformation centres around root cause problem solving. This approach results in break through performance improvements and builds Lean capabilities in pilot teams. This approach is similar to the microcosms described by Swank (Swank, 2003). For reporting the PMO office has no requirements to the CI Facilitator in phases three and four.

Phase five, the implementation and rollout planning. This phase cascades the target up to production line level. It defines continuous improvement programs per production line and sets up a rigorous performance management. The vision of this performance management is shown in figure 31. Key element in this vision is mentoring. Mentoring means day-to-day, hands-on coaching and guidance of the workforce by leadership and content experts at the micro-process, hands-on level. The coaching must continue for a sufficient period to establish new habits, expectations and behaviors. Training on continuous improvement tools and creating a good understanding of the goal is very important to achieve mentoring in its best way. This will finally result in a mindset for continuous improvement throughout the company.

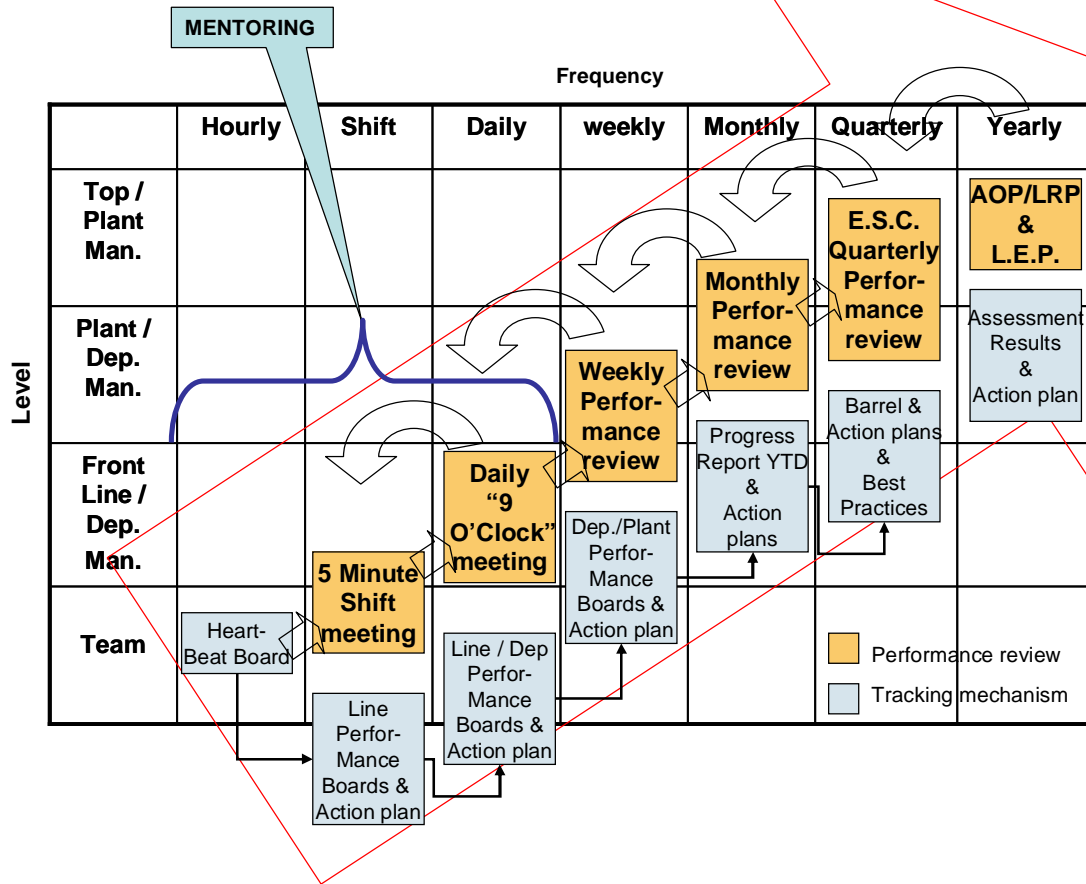

Figure 31: Performance Management

This fifth phase sets up an implementation follow up process. The SmartTool will be used as project management tool. Before the SmartTool is ready to be used in the subsequent Rollout Phase the PMO office needs a SmartTool request form(appendix D). This form provides the PMO team with project characteristic information necessary for creating a unique SmartTool. The SmartTool request form is an online document at the support site. For reporting the Final Report Out has to be reported to the CI directors. The document can be uploaded to the PMO site through the local team site. Using the same feature of the site that is in place for the diagnostic report out and the monthly status report.

In the initial rollout phase the target state, target Benefit has to be defined. When having difficulties in translating the key performance indicators into a financial benefit the continuous improvement director can be contacted. As soon as the target benefit is known the project charter has to be updated on SLC InSite with the Expected Financial Benefit in \$. This figure is the project to date financial benefit for end of the next fiscal year. The project charter also has to be updated on project phase.

Phase six is the rollout of all plans created in earlier phases. The SmartTool is created by the PMO office and will be send to the CI Facilitator. A separate document on how to use the SmartTool is attached and also available on the support site. Projects benefits and operational profit input in the SmartTool are used for financial reporting to Sara Lee Corporate.

Operating profit are all CI changes which have an impact on the P&L statement. The project benefits are the balance sheet, the KPI impacts as well as the operating profit impact. The project benefits can be equal to the operating profit impact, very often project benefits will be higher then the OP impact.

In all circumstances the CI facilitator should contact the PMO office to agree on the content of target and actual data to be recorded before any upload of data through the Smarttool. The target benefit and operating profit have to be populated up to end of the next fiscal year 08. If the project ends before the end of fiscal year 08, the financial figure of the last period must be extended. It results in a straight line that is copied to the end of the fiscal year. Also the respective annual operating plan (AOP) has to be populated. If a project results in Operating Profit the CI Facilitator must also report Benefits Upload the Targets and AOP values directly to SLI InSite through the Sync function.

To upload the targets, AOP values figures and number of people trained on continuous improvement principles to the SLI InSite environment the SmartTool is linked to the intranet. A synchronisation button is available in the SmartTool to start the synchronisation process. This process will take several minutes to complete the exchange of data.

#### 4.4.3 Reporting requirements

The table below represents the reporting requirements set by the CI department to the CI Facilitators.

Weekly Ongoing Reporting	Starts in Phase	Deadline
<p><b><i>Rolling Forecast (update)</i></b>                      The Rolling Forecast is an 8 week forecast showing the planned CIW's, Implementation Events, or other Key Events of all projects. When planning CIW's, Implementation Events or other Key Events or changes take place, the Rolling forecast has to be updated. CI Facilitators can find the Data Entry Form for the Rolling Forecast on the CI Support site under "Rolling Forecast". How to fill it in is described in the CI Tooling manual which can be found on the CI Support site. An example of the Rolling Forecast is available in appendix E.</p>	<p>Preparation (Phase 1)</p>	<p>Each Thursday</p>

Monthly Ongoing Reporting		
<b>Update % complete / Status / stoplight</b> Each month (second Tuesday after PEC) the items stoplight, % complete and status comments have to be updated on the SLC InSite project charter	Preparation (Phase 1)	2 <sup>nd</sup> Tuesday after PEC
<b>Actual Benefit / Operating Profit</b> Each month (second Tuesday after PEC) the period actual (Benefit and Operating Profit (if applicable) must be entered in the SmartTool and uploaded to InSite by using the Sync function. How to enter the data in the SmartTool is described in the CI Tooling Manual (P.20 onwards)	Rollout (Phase 5)	2 <sup>nd</sup> Tuesday after PEC
<b>People Trained</b> Besides Financials also the number of people trained should be reported through the SmartTool. Each month (second Tuesday after PEC) the numbers should be uploaded together with the actuals. People trained are cumulative numbers.	Rollout (Phase 5)	2 <sup>nd</sup> Tuesday after PEC
<b>Monthly Progress Report</b> The Monthly Progress Report has to be uploaded each month to the CI PMO site through the local team site. The template can be found on the CI Support site under the CI Reporting page.	Rollout (Phase 5)	2 <sup>nd</sup> Tuesday after PEC

Table 4: Reporting Requirements

## 4.5 Training structure

Implementation of continuous improvement in the organisation is creating a mindset. Employees have to get acquainted to the principles of continuous improvement by training them and practising these principles. M. Kerrin proved that continuous improvement is not simply a bottom up initiative perceived to be easy to implement. Continuous improvement has many links to top down and structures which are important (Kerrin, 1999). I already argued in the last paragraph of chapter three that top management needs to support the ideas. They therefore also need to get trained and understand continuous improvement. However a functional head will need a different kind of training compared to a line operator in the factory. I realised different kinds of trainings needed to be set up. To realise this I created a hierarchy of different training levels. These levels have become standard for Sara Lee International. Five different levels can be distinguished:

1. Sponsor training
2. CI Faciliator
3. Team Leader
4. Team Member

## 5. Awareness training

From sponsor training to awareness training, the five levels will be described by their specific characteristics.

The Sponsor training has a focus on global leadership team members, member of executive steering committee(ESC) and member of a country board. The training educates its participants on the principles of continuous improvement. The sponsor are important in a process of organisational change. Sponsor form a surface supporting the ideas of continuous improvement changes (Savolainen, 1999). In the sponsor training examples of successful companies are shown and the participants are informed about concepts, techniques and tools. The training provides the global knowledge to the participants in a one and a half day training.

The CI Facilitator training focuses on training continuous improvement group leaders and continuous improvement change agents. It is a program for individuals who are directly responsible for executing CIWs and Kaizen events tied to significant AOP initiatives. This training program is dedicated to educate the participants profound on all key principles of continuous improvement. Participants are trained on using tools and how to explain tools in their own training sessions. CI Facilitators are expected to start training sessions themselves. These can be continuous improvement workshops or awareness events. They work in a pattern also known as coach leadership mode. They will be conveying ideas into the organization, sometimes by using coercive power and dealing with counter forces (Savolainen, 1999). To be able to run these events successful they also receive training on didactic level and abilities. The training program has a duration of eight to twelve weeks.

The third training level is Team Leader. The team leader training is focussed on managers or professionals leading a continuous improvement activity, like a roll-out of an implementation in the process they are responsible for (mostly starting with a CIW/ Kaizen-event / Diagnostic). They are responsible for implementing continuous improvement in their daily work as part of a country or unit roll out. This training normally takes two days in training on Lean Daily Management Systems(LDMS).

Just below the level of team leader training is the team member training. This is a one day workshop focused on continuous improvement basics for employees who may be involved in a process undergoing improvement.

The last training program is the awareness training. An awareness training is an online module focused on the basic principles, definitions and application of Lean to drive continuous improvement. A live 2-hour version of this training can be provided to groups based on their needs. It can also be an event that is part of a bigger gathering like the opening of a Marketing Excellence Training, Outdoor session of Key Managers in a country or a regular Key Managers meeting.

To report on the number of employees trained within a project I created a separate part in the SmartTool. Named Lean Development where the CI Facilitator can report the cumulative number of people trained in each kind of

training. These training figures are reported on a monthly basis. By gathering these figures in a central Excel file they can be translated into figures for usage in the presentation for the board of management or visual displays on whiteboards. In the deck for the board of management it is reported how many employees have been trained in on of the five training levels, which is a total number per training. Second is a figure on trained FTE by functional area and similarly a figure on number of trained FTE per country. These two charts are displayed by percentage of the total number per functional area respectively per country. The last two charts concern the critical mass per functional area and per county. These graphs represent the changes from period to period in functional area respectively in each country. An example is shown in figure 32. It shows the percentage on the vertical axis of all people trained per functional area. The functional areas are represented on the horizontal axis. The bars are seperated in periods. For instance in supply chain a lot of people have been trained in period 3 and period 4. However, in DECS period 5 and 6 have a large percentage of people trained.

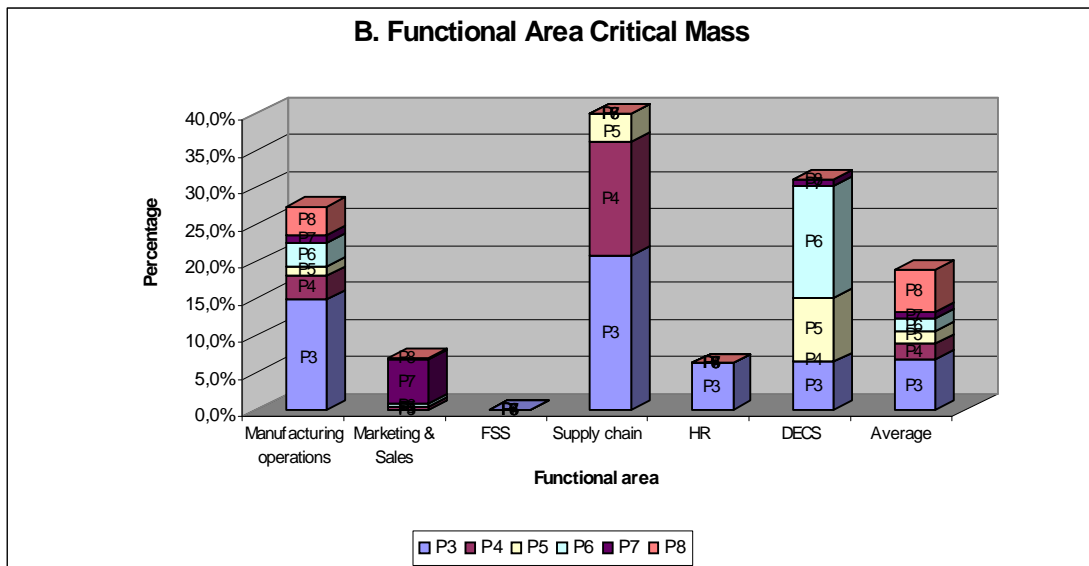

Figure 32: Functional area critical mass

## 5. Proposed solution

The previous chapter presented a future state for reporting progress on implementing continuous improvement. A special hierarchy structure was developed. This hierarchy structure cooperates with the SmartTool, used at the second level in the hierarchy structure. Besides these two elements I also recommended a common process for implementing continuous improvement.

On a question to an employee to describe continuous improvement they provided the following answer:

*We are constantly working on improvements. These improvements arise from within the team and are not forced from above. Everybody is concerned in this process actually this level of concern is even growing. It is nice to see that CI is proving successful. A lot of targets have already been achieved and quality and service is only going up. It is not just another cost saving operation forced from the top.*

This answer touches the bottom line of continuous improvement. The service is going up by ideas and improvements from local workers. They are not forced to do more or better, they want to be better every new day in the future.

In chapter four the future state has been described. Figure 33 represents this structure created which I created in November for Sara Lee International to report in a separate environment on continuous improvement.

The InSite environment is accessible for all employees. This maximizes the opportunity for creating a mindset on continuous improvement. The organization has to get trained and start working with continuous improvement tools. By having all material and data for Sara Lee International located in one central site employees can learn about the organizational change right from their own workplace or desktop. The SLI CI page is connected to the SLC CI page which will function as co-ordinating site. On the SLC layer the project charters are stored. These charters can first be sorted on business segment. The upper management can per business segment check project phases. For managerial purposes more important are the project stoplights. These will immediately trigger the management for actions.



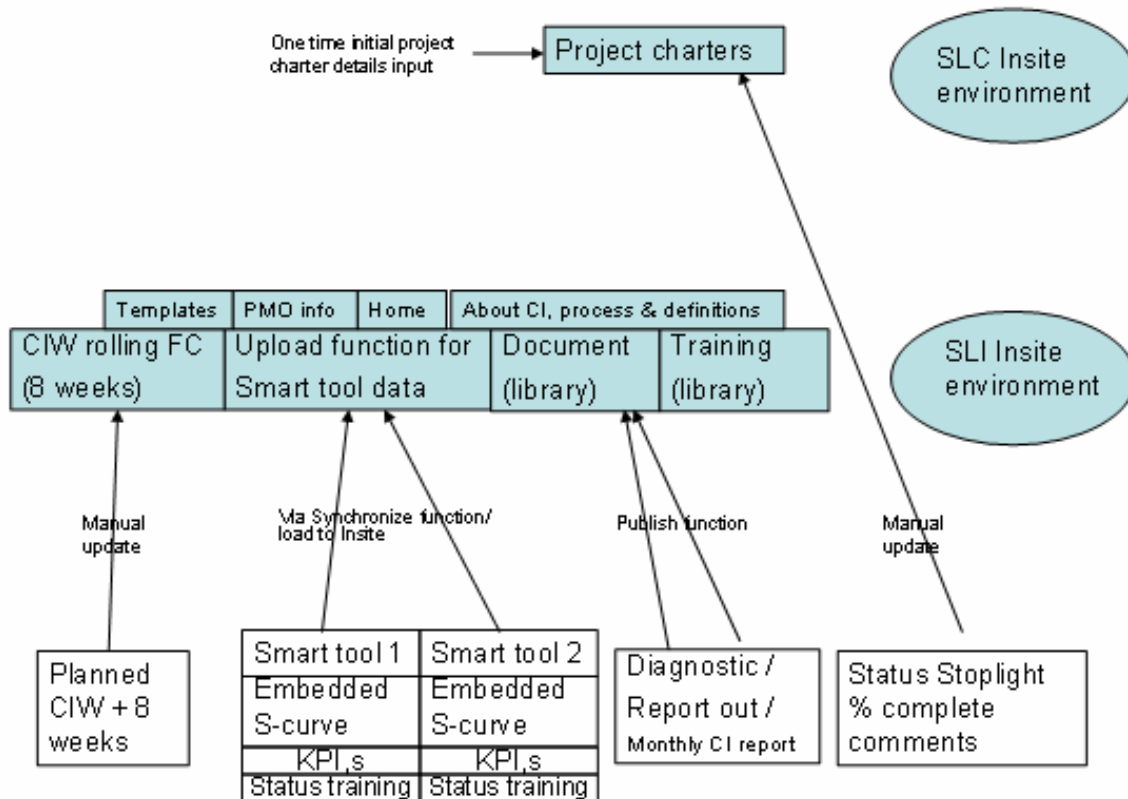

Figure 33: New reporting structure

On the SLC CI page the overall s-curves will be on hand. The s-curves will first provide a display of the total situation. That as a starting point and next there is the ability to present the figures per segment or per project. The underlying local figures will be available on the SLI page. The upper management will be concerned with the result of the projects. What happens within these projects is described in the project charters. Figures of local targets and actual figures per period will be used by the CI department for steering on and hand on coaching. I refer to mentoring as the key for performance management.

The SLI CI page will also be linked top down to all local SmartTools and the local team sites. Linking all these sites enables for the CI facilitators to access an environment where they can share their personal findings. They can celebrate team successes and provide best practices for the rest of the organization. The local team sites have a standard design. the PMO team used the weekly telephone conference with CI Facilitators as input. We asked them what were desired features they would like to use. Based on their answers a team site was equipped with an agenda showing the upcoming events. InSite links were provided to quickly navigate to site parts which were reported in the reporting requirements. This made it more accessible and saved time in reporting. This freed time can then be applied for the

essence of process improvement ie analysis and creating improvement strategies.

Best practices and achievements for different fields of expertise are shared in a monthly briefing. This CI news bulletin is published on the overall InSite homepage and in some countries even distributed by mail to all the employees. This bulletin and moreover this open way of sharing achievements will encourage teams to set new performance measures. They will try to perform even better and out perform their last reported period. Enthusiasm will grow among the whole organization and the number of improvements will rapidly increase.

The continuous improvement site for SLI includes on online version of the Rolling forecast. This section displays all CIWs or Kaizen events, like an agenda. The events can be sorted in different ways as wished by the user. Either sort per initiative, project, country, CI facilitator, start date, end date or per sponsor. The rolling forecast serves different purposes. It can either be the agenda for a CI Facilitator. For upper management the rolling forecast is a display of all activities within SLI and provides a simple overview of where to visit an activity or which person to contact for more information on the purpose and the goals set for the activity.

On the SLI CI page there is also a section where the SmartTool data of all projects is available. This data can be sorted in various ways. This is possible by using the sort options created for managerial control. Status reports and report out of a CIW are visible in the library function and the training set in maintaining all training material on continuous improvement This results in the following reporting structure which is originated and running.

The new designed environment within InSite for continuous improvement divided in two management support fields(figure 34).

1. Corporate Management Support
2. Local Management Support

The corporate management support involves the upper section of the InSite environment. The information from SLI CI initiatives which is consolidated towards this part is to be used for corporate control. The information is the medium for steering initiatives and the direction of implementation. A representation of the situation is shown below.

The second part is directed for local management support. This information is not directly available to corporate divisions. The information is used by the CI department to steer each initiative and project within the initiatives. Within operations or non-operations the manager responsible can closely watch the progress and analyse the activities. Documents are available to track the monthly status and outcomes of a CIW.

By using the reporting structure the CI department has tools available to steer and guide on all elements.

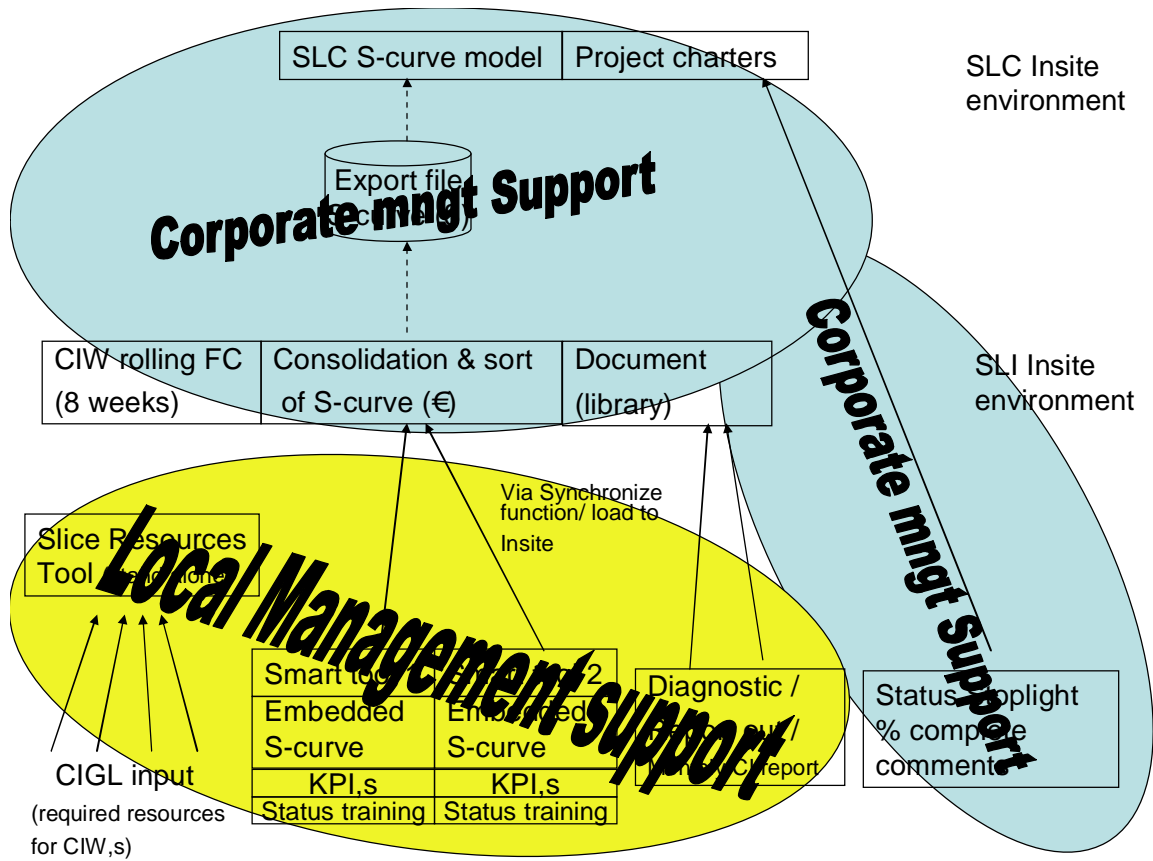

Figure 34: Corporate and local support

## 6. Conclusion and recommendations

The focus of this report was to create a reporting structure for Continuous Improvement. This structure had to facilitate progress reporting as well as financial reporting on the implementation of continuous improvement. A challenging assignment as it had to be finished by the end of October, November at last. I performed a survey on the actual situation and presented in chapter two of this research. This analysis of the current state is a vital step as it forms the basis for the process. It showed Sara Lee Corporation was already a few years ahead in time and operations had also already started initiatives. For reporting CI progress in SLI a special environment was needed.

My first research question was what is continuous improvement exactly? I performed a literature study to get familiar with the subject of continuous improvement. Continuous improvement is a process of 5 key elements working together in a virtuous circle. Value, Value stream, Flow, Pull and Perfection. These key elements are explained in the third chapter. Summarized in one sentence continuous improvement is a process of getting the right things to the right time in the exact quantity by minimizing waste and being open and flexible for change. For Sara Lee this is not only applied on manufacturing but also on non-operations.

By applying continuous improvement to non-operations Sara Lee is entering an undeveloped area. Not much is known about applying continuous improvement to non-operations. The key element in continuous improvement is the map of the value stream. I finished chapter three with a framework which would focus on value stream identification. In operations the value stream map is often quite easy to draw. In non-operations it is often hard to do so because there is no physical stream. I developed a new hierarchy structure for the new situation in which the value stream has its own hierarchy level. This highlights the importance for everyone involved in the process to carefully look at their processes and map the value stream. This value stream map is the basis for the ideal state. If the map of the value stream is not done correctly the process of continuous improvement will head in the wrong directions. Based on the wrong picture of the current situation a fake ideal situation will be created and result in a future state which is not really improving.

The value stream is also a special phase in the reporting structure for operations and non-operations. In operations the second phase is all about the analysis of the value stream. Every single station / machine in a value stream will be examined. Based on those findings the improvement potential is reported in a report out. In non-operations the continuous improvement workshop focuses on the value stream. The question arises on what is actually happening during our process. Which steps are taken, what is the sequence of these steps and how much time and effort do they require? The

participants of a workshop get conscious of their own working procedures and the waste which is incorporated.

In the soll state I questioned if a common reporting structure was able for operations and non-operations. The new reporting structures are explained in paragraph 4.4 and are nearly the same. The process for operations contains two extra steps as a result of the substantial bigger size of the projects. By designing a common process for all projects in Operations and Non-operations a much higher level of insight is given to participants in a project. Even more important is that an employee, whether he is a manager or a line operator can quickly see what the status of a project is. This process was based on the cyclical way organizational change was described in theory. The new processes are described in chapter four and serve as models on the insight environment. The pictures are separated and linked to their description. These describe what is happening per process step and also set the requirements to proceed to a next step.

The common process for continuous improvement is not just a straight forward process. It is a cyclical process. This process incorporates a high level of performance management. Performance management is a second element of the framework I constructed in chapter three. In this cyclical process first a planning is needed to create a schedule and a plan about an improvement on a machine or process. This plan has to be executed by a team, built up of people involved in the process. They are also involved in setting up the plan. This reveals show the bottom up methodology of continuous improving. A check of the new situation is needed to see if the future state is achieved. If not, adjustments can be made or by starting a new cycle the incremental improvement can proceed. These plan do check act circles are also reflected in the SmartTool. The ideas can be entered into the SmartTool. Ideas can be just an idea, or they can be an approved idea which will be implemented on a short term. The differentiation in the ideas can be visualized in the S-curve. This image shows a clear picture of how the project is performing. It contains the target line and an actual line with the ideas for future improvements to reach the target.

An organizational change needs to be backed by the organisation. Responsible for a change is the top management. They have to firmly support and stand behind the ideas of continuous improvement. In the end however the improvement has to be made on the process or production line. Middle management and line operators therefore play an important role. The last element of the framework was clear training structure for implementing continuous improvement. To facilitate the organization in getting an understanding of continuous improvement I have realized a training structure which is able to train every level of the organization. On the line a small awareness event can be organized about implementing a continuous improvement tool. Whereas and extensive CI facilitator program is available to train leading figures for implementing continuous improvement in all part of the organisation. Inserting the people trained element in the SmartTool

---

provides the CI Department with an easy way of tracking the number of people involved in the continuous improvement process.

For ongoing implementation of continuous improvement an evaluation is needed. After months of work and effort inserted in this reporting structure the CI department needs to evaluate the status of the process. During my research I found several articles on evaluating the phase and level of implementation. What is the current situation? The evaluation will enable the CI department to set new marks for the implementation of continuous improvement. I would like to recommend Sara Lee International to use the reporting structure and evaluate the current state of the implementation.

What I finally need to stress is that continuous improvement will be there for a lifetime. It may not be abused as a management tool for a couple of years. If so, it will be doomed to fail. The organization has to use all efforts to support new developments and celebrate achievements. LEAN is about creating a mindset for continuous improvement throughout the organisation.

---

## References

- Kerrin, M. (1999). "Continuous improvement capability: Assessment within one case study organisation," *International journal of operations & production management*, Vol. 19 No. 11, pp. 1154-1167
- Womack, J.P. e.a. (2003). "Lean thinking" First press. New York: Free Press
- Jones, D (2006). "Lean manufacturing college" Lecture at Sara Lee International in Utrecht
- Bond, T. (1999). "The role of performance management in continuous improvement," *International journal of operations & production management*, Vol. 19 No. 12, pp. 1318-1334
- Rother, M. e.a. (2003). "Learning to see. Value stream mapping to create value and eliminate muda" Version 1.3, The Lean Enterprise Institute, Cambridge
- Glenday, I.P. (2005). "Breaking through to flow" Version 1.0, Lean Enterprise Academy Ltd, Ross-on-Wye
- Kaufman Global (2006). "Standard work tools" Module 2 Continuous Improvement Group Leader training.
- Savolainen, T. (1999), "Cycles of continuous improvement: realizing competitive advantages through quality," *International journal of operations & production management*, Vol. 19 No. 11, pp. 1203-1222
- Swank, C.K. (2003). "The lean service machine," *Harvard Business Review*, Vol. 81 No. 10, pp. 123-129

## Glossary

AOP	Annual Operating Plan
CFO	Chief financial officer
CI	Continuous Improvement
CI Department	Continuous Improvement department
CI Facilitators	Continuous Improvement facilitators
CIGL	Continuous Improvement Group Leaders
CICA	Continuous Improvement Change Agents
C&T	Coffee and Tea
DECS	Douwe Egberts Coffee Systems
EPEC	Every Product Every Cycle
FTE	Fulltime Equivalent
H&BC	Household and Bodycare
InSite	Intranet environment
KPI	Key Performance Indicator
LDMS	Lean Daily Management Systems
OEE	Overall Equipment Efficiency
Period	Month
PMO Team	Project Management Organization team
Prio Process	Priority Process
S&OP	Supply and operations
Senior VP	Senior Vice President
SLC CI InSite	Sara Lee Corporation Continuous Improvement InSite
SLI CI InSite	Sara Lee International Continuous Improvement InSite
SLC	Sara Lee Corporation
SLI	Sara Lee International
SMART	Specific, Measurable, Achievable, Relevant and Time
TPS	Toyota Production System
VP	Vice President



# Appendix A

## High level implementation plan for continuous improvement

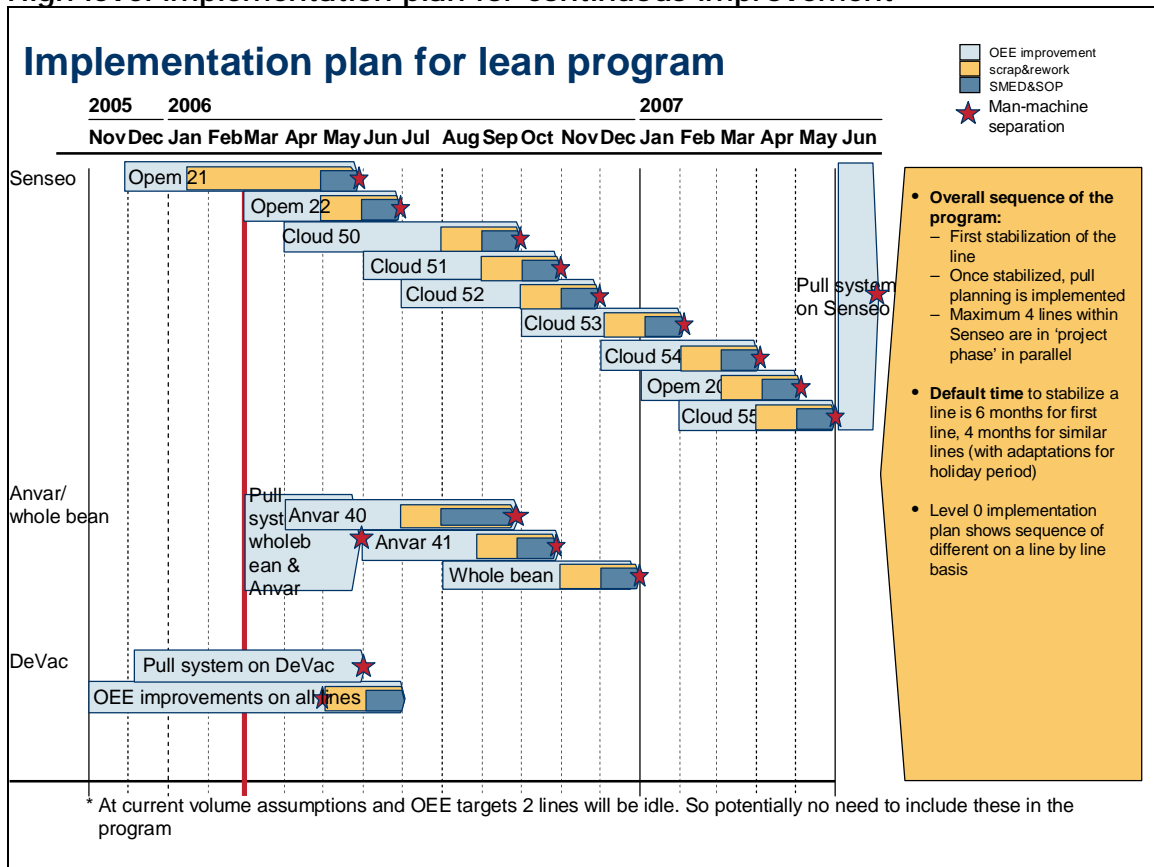

### One level below for a more detailed planning

#### Level 1: implementation plan follows structured approach

Level 1: Senseo value stream		Level 1: Traditional value stream							
Line	Objective	Sub. objective	Impact OEE Percent	FTE	Scrap	Sub. workstream	Duration	Start	End
Senseo	Performance management	-	-	-	-	Introduce performance boards	1 month	01/03/06	1/04/06
Senseo	Introduce 5-minute mtg.	-	-	-	-	Introduce 5-minute mtg	1 month	01/03/06	1/04/06
Senseo	Gradual form C/O Team Opem	Task specialization	-	+5.7	-	SMED Kaizen	2 months	01/05/06	1/07/06
Senseo	Gradual form C/O Team Cloud	Task specialization	-	+3.4	-	SMED Kaizen	2 months	01/09/06	1/10/06
Senseo	Install Pull system	-	-	-	-	Introduce Kanban system	2 months	01/05/07	1/07/06
Cloud 50	Basic lean training	Training lean principles	-	-	-	Mambo Jumbo training	1 week	01/03/06	8/03/06
Cloud 50	Basic lean training	Training in 55 principles	-	-	-	55 workshop	1 week	01/03/06	8/03/06
Cloud 50	Performance management	-	-	-	-	Introduce performance boards	1 month	01/03/06	1/04/06
Cloud 50	Performance management	-	-	-	-	Introduce 5-minute meetings	1 month	01/04/06	1/05/06
Cloud 50	OEE-improvement	Reduce technical failure	5	-	-	Series of Kaizens to eliminate Top 3 causes	6 months	01/04/06	1/10/06
Cloud 50	OEE-improvement	Reduce technical failure	5	-	-	Standardization and elimination of setting and interventions	6 months	01/04/06	1/10/06
Cloud 50	OEE-improvement	Reduce operational losses	3	-	-	Small technical adaptation incl. Improvement memo's	6 months	01/04/06	1/10/06
Cloud 50	OEE-improvement	Reduction of uptime	2	-	-	Series of Kaizens to eliminate top 3 causes	6 months	01/07/06	1/10/06
Cloud 50	Man - machine separation	-	-	-	-14.1	SMED analysis and visual work instructions	1 month	01/09/06	1/10/06
Cloud 50	Scrap and rework reduction	-	-	-	-	Standard work instructions	3 months	01/07/06	1/10/06
Cloud 50	Pull system	-	-	-	-	Series of Kaizens	1 month	01/06/07	1/07/06

# Appendix B

Sara Lee International

Finance Manual

Subject:	KPI's Supply Chain		Number:	
			Page:	1
Valid:	14 Maart 2007	Supersedes	Date	17 Januari 2007
Date:	14 Maart 2007			

<b>1</b>	<b>INTRODUCTION</b> .....	<b>2</b>
<b>2</b>	<b>CHANGES P09 VERSUS P06</b> .....	<b>3</b>
<b>3</b>	<b>KPI'S PER LINE OF BUSINESS</b> .....	<b>4</b>
3.1	GENERAL .....	4
3.2	INVENTORY TURNOVER (ITO) .....	4
3.3	SLOB: SLOW MOVING BALANCES (LOCAL CURRENCY *000) .....	5
3.4	SLOB % OF TOTAL INVENTORY .....	5
3.5	OBSOLETE AS PART OF TOTAL STOCK .....	5
3.6	# OF OUT OF STOCK DAYS .....	6
3.7	W&D COSTS AS % OF NOS .....	7
3.8	W&D COSTS PER PALLET .....	8
3.9	ORDER FILL RATE ON TIME IN FULL .....	9
3.10	CASE FILL RATE IN FULL .....	10
3.11	FORECAST ACCURACY VOLUME .....	11
3.12	BROKEN LAYERS .....	12
<b>4</b>	<b>SUPPLY CHAIN SHARED SERVICE CENTER KPI'S</b> .....	<b>13</b>
4.1	GENERAL .....	13
4.2	INBOUND COST PER PALLET .....	13
4.3	COUNTRY SUPPLY CHAIN COSTS .....	14
4.4	COUNTRY SCSSC FTE'S AT PERIOD END .....	14
4.5	REPACKING COST % AS PART OF COGS .....	15
4.6	CUSTOMER ORDER - NUMBER OF ORDERS .....	16
4.7	CUSTOMER ORDER - SHIP TO .....	17
4.8	CUSTOMER ORDER - NUMBER OF CASES .....	18
4.9	CUSTOMER ORDER - % OF EDI/CRP ORDERS .....	19
4.10	SKU'S SOLD NEW/SOLD PROMOTIONAL .....	20
4.11	SKU ACTIVITY LEVEL .....	20
4.12	GENERAL CI INFORMATION .....	21
4.13	COST REDUCTION / MARGIN IMPROVEMENT .....	21
4.14	EMPLOYEES TRAINED ON CI .....	21
4.15	CI TRAINERS .....	21

Subject:	<b>KPI's</b>		Number:	
	<b>Supply Chain</b>		Page:	<b>4</b>
Valid:	14 Maart 2007	Supersedes	Date:	17 Januari 2007
Date:	14 Maart 2007			

### 3 KPI's per Line of Business

#### 3.1 General

The KPI's in this chapter will be generated per line of business. More specific, in the report you can analyze the data for the C&T, H&BC and C&T Foodservice division separate from each other. The data for these KPI's will be collected in the MSU and C&T Foodservice part of the KPI WDEF's.

#### 3.2 Inventory Turnover (ITO)

##### 3.2.1 KPI Definition ITO:

Definition: Number of times the inventory has been sold on an annualized base.

Numerator: Cost of Sales

Denominator: Inventories Cost

##### 3.2.2 Calculation Periodic:

Numerator: Sum 3 periods 4\_CS\_SUBTOT

Denominator: Average 4 periods 1\_INVTY\_COST

Dimension: 3 months average

Multiplier: -4

Rounding: 1 decimal

Unit of measure: #

##### 3.2.3 Calculation MAT:

Numerator: Sum 12 periods 4\_CS\_SUBTOT

Denominator: Average 13 periods 1\_INVTY\_COST

Dimension: MAT

Rounding: 1 decimal

Unit of measure: #

## Appendix C

### Project Charter on Sara Lee Corporate CI InSite

Project Title	3 Bean Coffee Optimization
Initiator	Flitkin, Talle
Key Exec Reference	
Product/Process	3 Beans
Business Segment	<a href="#">renaissance</a>
Business Unit	<a href="#">BU Operations</a>
Functional Area	Supply Chain
Country	USA
Business Affiliation	3 bean coffee supply to factories (of the main secondary contract) JUSCI - 12.5 lbs/100 green coffee in 21 countries and 8 ports for the US, Europe, SA, Africa, India - the collection of the containers, check quality in a meeting in the USA, in the rest of the world, put on orders, take care of the paperwork, shipping and distribution
Objectives	Reduce the space into 220m in associated cost of freight, storage, working capital, handling and avoid the expediting with 3 bean coffee by reducing variability (some up some)
Steps	Step -1 (Current freight process) Step -2 (Testing of coffee in 3 beans) Step -3 (Implementation of freight) Step -4 (Final analysis)
BU Functional Lead / Sponsor	<a href="#">Jan Azevedo</a>
Other BU Lead (S, M, C, P, Q)	<a href="#">Corder, Alex</a>
CI Team Leader	<a href="#">Fanning, John</a>
CI Team Members	Michael Dierks, Jeff Gilmer, Loretta, Heather Lawson, Andy Lotho, Michelle Lane - Sara Lee Haven, Deborah Stepan, Mark Pittman, Amy Zentgraf, Cathy Mahoney, Jason M. D. Lopez, Lisa O'Brien, Mark D. Kinsch, James, Mark Grindell, Greg - D. Corder
High Level Milestones	2007/10/25 Logistics; 210000 Logistics with Quality; Procurement
Next Milestones	
Start Date	01/15/2008
Complete Date	5/15/2008
Key Activities/ Tasks	Map the current freight process Find the current supply network (Simulink analysis) Identify the value of freight and cost (less complexity)
Deliverables	Final project presentation Current freight process Less freight cost Lower Service Level to factories

Future Sales %/s	<ul style="list-style-type: none"> <li>1) Int'l Logistics consulting of green vehicles</li> <li>2) merge joint 50% with joint 50%</li> <li>3) new line of the current business (e.g. 1) Int'l new line of the current business</li> <li>4) E.C. of response center support</li> </ul>
Expected Financial Benefits:	9% / yr
Financial Assumptions:	<ul style="list-style-type: none"> <li>Capital costs savings (45%) = 200 / yr</li> <li>Assembling related systems (other technology) = 100 / yr</li> <li>new design 15% = 100 / yr</li> <li>Value added 15% = 100 / yr</li> <li>Full-time program costs (4%) = 500 / yr</li> <li>Operational (O.P.C.) = 200 / yr</li> <li>Less = 450 / yr = 100 / yr</li> <li>ROI = 400 / yr</li> </ul>
Key Financial Benefits:	<ul style="list-style-type: none"> <li>1) increase quality of services for vehicles (on-line information &amp; support)</li> <li>2) improve customer service (online customer support center) (on-line information &amp; support)</li> </ul>
Reduced Risks (Qual. and IP/SC)	<ul style="list-style-type: none"> <li>1) Turnover Rates</li> <li>2) Job Costing</li> <li>3) Quality Control</li> <li>4) Inventory</li> <li>5) Customer Support</li> <li>6) Turnover Rates</li> <li>7) Job Costing</li> <li>8) Quality Control</li> <li>9) Inventory</li> </ul>
Disposition Status:	Active
Phase / Phase:	3, make a contract
Goal/Obj:	1, 2, 3
Status/Comments:	<ul style="list-style-type: none"> <li>1) Merge (response) 1, 2, 3, 4, 5, 6, 7, 8, 9, 10, 11, 12, 13, 14, 15, 16, 17, 18, 19, 20, 21, 22, 23, 24, 25, 26, 27, 28, 29, 30, 31, 32, 33, 34, 35, 36, 37, 38, 39, 40, 41, 42, 43, 44, 45, 46, 47, 48, 49, 50, 51, 52, 53, 54, 55, 56, 57, 58, 59, 60, 61, 62, 63, 64, 65, 66, 67, 68, 69, 70, 71, 72, 73, 74, 75, 76, 77, 78, 79, 80, 81, 82, 83, 84, 85, 86, 87, 88, 89, 90, 91, 92, 93, 94, 95, 96, 97, 98, 99, 100</li> </ul>
% Complete:	75%

## Appendix D

### SmartTool Request form

SMART TOOL REQUEST FORM				
Requested by		Theo Goutier		
Request Date		24 november 2006		
Initiative Name		Green Coffee Supply Chain Optimization		
Project Name		Green Coffee Supply Chain Optimization		
Line of Business		C&T		
Country		Other		
Prio Process		None		
Functional Area		Supply Chain		
CI Facilitator (CICA,CIGL)		Goutier, Theo;		
On top of Transformation (yes/no)		Yes		
On top of ADP (yes/no)	AOP07 AOP08 AOP09 AOP10	Yes No No No		
Operations (yes/no)		Yes		
Start Date (mmm-yy)		jun-06		
End Date (mmm-yy)		mei-07		
Local Currency		EUR		
Process Structure		<b>Valvestream</b> Utrecht Joure Grimbergen Andrezieux Kolding Mollet des Valles Bremen Subsczewo Budapest DECOTRADE	<b>Production Line / Sub Process</b>	
KPI Definition <a href="#">KPI definitions within Sara Lee International</a>		<b>Short Name</b>	<b>Unit of Measurement</b>	<b>Presentation Format</b>
Set your KPI's as much as possible to existing the KPI's !	KPI 1 KPI 2 KPI 3 KPI 4 KPI 5	IPO Green Coffee (invoiced) Logistics Cost (from origin) Emergency SPOT supply Regrading at Factory	# weeks Euro/ton Euro % of tons received	0,0 00,0l 0,0kl 0,0%
Focus areas	Focus Area 1 Focus Area 2 Focus Area 3 Focus Area 4 Focus Area 5 Focus Area 6	Logistics (rates/network) Quality Control Information Technology Central stocking vs local Demurrage & Detention (CIW's)		
Activity leader	Activity leader 1 Activity leader 2 Activity leader 3 Activity leader 4 Activity leader 5 Activity leader 6	Gerry van Elst Etienne Moernaut Mark Sleijpen Leon Cramer Guido Sterckx		
Activity auditor	Activity auditor 1 Activity auditor 2 Activity auditor 3 Activity auditor 4 Activity auditor 5 Activity auditor 6	Rob van Laerhoven Han Meertens Leon Cramer Jeroen Janssen Lok Maarten Lemstra		

